



T-Slotted Framing and Fittings

Configure full-size machine guards, enclosures, carts, workstations, and more with standard T-slotted framing and fittings. This framing has continuous T-slots for attaching fittings. **Single-profile rails** come in a variety of profile options, so you can choose the number (from one to four) and position of open T-slots for connecting fittings.

 For technical drawings and 3-D models, click on a part number.

Single Rails—Aluminum

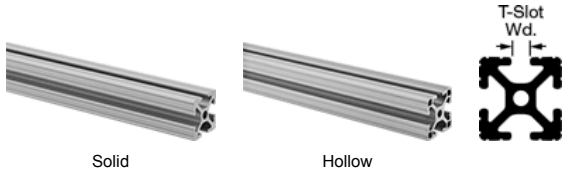

Solid rails are stronger than hollow rails.

Hollow rails are lighter and more economical than solid rails.

Rail Ht.	Rail Wd.	Rail Construction	T-Slot Wd.		1 ft.	2 ft.	3 ft.	4 ft.	5 ft.	6 ft.	8 ft.	10 ft.
Silver Anodized												
1"	1"	Solid	0.256"	47065T101	\$5.84	\$7.79	\$10.57	\$12.31	\$16.28	\$17.68	\$23.57	\$30.54
1 1/2"	1 1/2"	Hollow	0.32"	47065T102	7.18	13.98	20.30	25.25	31.32	36.99	48.42	57.82
1 1/2"	1 1/2"	Solid	0.32"	47065T103	10.30	18.19	23.71	27.30	34.88	38.57	55.18	67.73
20mm	20mm	Solid	5mm	5537T101	4.77	8.03	10.38	13.52	16.12	17.79	22.36	27.41
30mm	30mm	Hollow	8mm	5537T97	5.99	9.76	13.52	17.31	21.09	24.85	32.40	39.94
40mm	40mm	Solid	8mm	5537T102	11.44	20.64	29.89	36.73	44.64	53.00	68.91	85.30
45mm	45mm	Hollow	10mm	5537T103	8.69	14.50	20.70	26.75	31.64	37.32	50.07	61.30
Black Anodized												
1"	1"	Solid	0.256"	47065T503	6.73	11.05	15.36	19.68	—	28.30	36.94	45.57
1 1/2"	1 1/2"	Hollow	0.32"	47065T507	11.35	17.91	29.38	35.27	—	48.78	62.30	76.86
1 1/2"	1 1/2"	Solid	0.32"	47065T399	12.77	22.86	32.94	43.03	—	63.20	83.37	103.54
20mm	20mm	Solid	5mm	5537T514	7.19	8.37	12.60	15.85	—	22.40	28.92	35.93
30mm	30mm	Hollow	8mm	5537T511	9.04	11.12	16.55	20.13	—	29.07	38.01	46.87
40mm	40mm	Solid	8mm	5537T507	15.97	23.60	35.39	44.86	—	66.19	87.50	108.65
45mm	45mm	Hollow	10mm	5537T509	14.36	17.91	26.95	33.85	—	49.11	64.37	80.22
Yellow Powder Coated												
1"	1"	Solid	0.256"	47065T504	—	16.32	—	27.77	—	39.23	50.30	62.24
1 1/2"	1 1/2"	Hollow	0.32"	47065T508	—	24.84	—	47.74	—	67.50	87.26	108.89
20mm	20mm	Solid	5mm	5537T506	—	14.15	—	27.41	—	39.73	52.03	64.39
30mm	30mm	Hollow	8mm	5537T513	—	18.08	—	34.00	—	49.76	65.52	77.76
40mm	40mm	Solid	8mm	5537T508	—	29.84	—	57.67	—	85.54	113.39	141.00
45mm	45mm	Hollow	10mm	5537T512	—	25.31	—	48.42	—	70.95	93.49	115.24

Rail Ht.	Rail Wd.	Rail Construction	T-Slot Wd.		Per Inch
Silver Anodized					
1"	1"	Solid	0.256"	47065T801	\$0.57
1 1/2"	1 1/2"	Hollow	0.32"	47065T808	.69
1 1/2"	1 1/2"	Solid	0.32"	47065T802	1.00
20mm	20mm	Solid	5mm	5537T911	.42
30mm	30mm	Hollow	8mm	5537T919	.54
40mm	40mm	Solid	8mm	5537T913	1.00
45mm	45mm	Hollow	10mm	5537T915	.75
Black Anodized					
1"	1"	Solid	0.256"	47065T807	.53
1 1/2"	1 1/2"	Hollow	0.32"	47065T812	.87
20mm	20mm	Solid	5mm	5537T926	.39
30mm	30mm	Hollow	8mm	5537T933	.52
40mm	40mm	Solid	8mm	5537T928	1.01
45mm	45mm	Hollow	10mm	5537T931	.77
Yellow Powder Coated					
1 1/2"	1 1/2"	Hollow	0.32"	47065T813	1.19
20mm	20mm	Solid	5mm	5537T927	.63
30mm	30mm	Hollow	8mm	5537T934	.80
40mm	40mm	Solid	8mm	5537T929	1.29
45mm	45mm	Hollow	10mm	5537T932	1.12

Rail Ht.	Rail Wd.	Rail Construction	T-Slot Wd.		Per cm
Silver Anodized					
1"	1"	Solid	0.256"	47065T992	\$0.22
1 1/2"	1 1/2"	Hollow	0.32"	47065T984	.27
1 1/2"	1 1/2"	Solid	0.32"	47065T993	.39
20mm	20mm	Solid	5mm	5537T9	.17
30mm	30mm	Hollow	8mm	5537T902	.21
40mm	40mm	Solid	8mm	5537T904	.40
45mm	45mm	Hollow	10mm	5537T907	.29

Corner Brackets for Single Rails—Aluminum

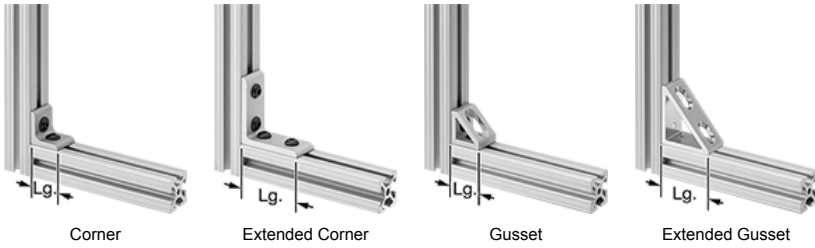

Corner brackets connect rails without machining. **Gusset corner** brackets limit sway in structures for more structural stability than other brackets.

For Rail Ht.	Lg.	Mounting Fasteners Included	Silver		Black	
			Each	Each	Each	Each
Corner						
1"	1"	Yes	47065T236	\$5.21	47065T831	\$5.60
1 1/2"	1 1/2"	Yes	47065T845	5.77	47065T833	6.27
20mm	3/4"	Yes	5537T935	5.82	5537T231	6.04
30mm	1 1/8"	Yes	5537T936	6.09	5537T232	6.31
40mm	1 5/8"	Yes	5537T937	6.38	5537T233	6.60
45mm	1 3/4"	Yes	5537T938	6.51	5537T234	6.73
Extended Corner						
1"	2"	Yes	47065T239	5.25	47065T311	8.75
1 1/2"	3"	Yes	47065T241	6.26	47065T312	10.70
20mm	1 5/8"	Yes	5537T441	7.90	5537T344	8.21
30mm	2 3/8"	Yes	5537T345	8.40	5537T346	8.65
40mm	3 1/8"	Yes	5537T347	8.73	5537T348	8.73
45mm	3 1/2"	Yes	5537T349	8.85	5537T351	9.17
Gusset						
1"	1"	Yes	47065T663	6.54	47065T669	7.61
1 1/2"	1 1/2"	Yes	47065T679	7.58	47065T695	8.83
20mm	3/4"	Yes	5537T518	4.67	—	—
30mm	1 1/8"	Yes	5537T536	5.36	—	—
40mm	1 5/8"	Yes	5537T586	6.89	—	—
45mm	1 3/4"	Yes	5537T594	8.16	—	—
Extended Gusset						
1"	2"	Yes	47065T736	9.99	47065T749	11.52
1 1/2"	3"	Yes	47065T762	11.92	47065T798	13.89
20mm	1 5/8"	Yes	5537T658	8.56	—	—
30mm	2 3/8"	Yes	5537T659	9.33	—	—
40mm	3 1/8"	Yes	5537T666	10.67	—	—
45mm	3 1/2"	Yes	5537T661	12.13	—	—

End Brackets for Single Rails—Aluminum



Outside Corner



Three-Way Outside Corner

End brackets require tapped holes to connect rails.

For Rail Ht.	Lg.	Mounting Fasteners Included	Silver	
			Each	Each
Outside Corner				
1"	1"	Yes	47065T242	\$6.83
1 1/2"	1 1/2"	Yes	47065T243	7.84
20mm	3/4"	Yes	5537T286	6.60
30mm	1 1/8"	Yes	5537T863	8.15
40mm	1 5/8"	Yes	5537T287	8.47
45mm	1 3/4"	Yes	5537T288	9.64
Three-Way Outside Corner				
1"	1"	Yes	47065T244	9.86
1 1/2"	1 1/2"	Yes	47065T245	10.78
20mm	3/4"	Yes	5537T289	9.55
30mm	1 1/8"	Yes	5537T864	10.04
40mm	1 5/8"	Yes	5537T291	11.18
45mm	1 3/4"	Yes	5537T292	11.73

Surface Brackets for Single Rails—Aluminum

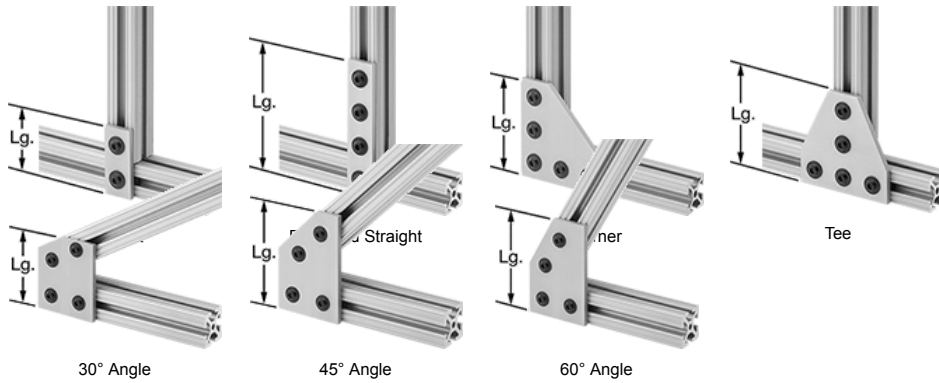

Surface brackets connect rails without machining.

For Rail Ht.	Lg.	Mounting Fasteners Included	Silver		Black	
			Part No.	Each	Part No.	Each
Straight						
1"	2"	Yes	47065T255	\$6.07	47065T832	\$6.36
1 1/2"	3"	Yes	47065T256	6.39	47065T834	6.84
20mm	1 1/2"	Yes	5537T944	6.87	5537T253	7.20
30mm	2 1/4"	Yes	5537T945	7.73	5537T254	8.07
40mm	3"	Yes	5537T946	7.82	5537T255	8.16
45mm	3 3/8"	Yes	5537T947	7.93	5537T256	8.27
Extended Straight						
1"	4"	Yes	47065T259	6.07	47065T313	9.49
1 1/2"	6"	Yes	47065T261	6.66	47065T314	11.06
20mm	3"	Yes	5537T948	9.49	5537T258	9.82
30mm	4 5/8"	Yes	5537T949	10.13	5537T259	10.44
40mm	6 1/8"	Yes	5537T951	10.49	5537T261	10.82
45mm	6 7/8"	Yes	5537T952	10.96	5537T265	11.51
Corner						
1"	3"	Yes	47065T267	7.62	47065T317	12.04
1 1/2"	4 1/2"	Yes	47065T271	8.77	47065T318	14.36
20mm	2 3/8"	Yes	5537T962	10.18	5537T266	10.53
30mm	3 1/2"	Yes	5537T963	12.11	5537T267	12.11
40mm	4 5/8"	Yes	5537T964	14.27	5537T279	14.62
45mm	5 1/4"	Yes	5537T965	14.78	5537T281	15.11
Tee						
1"	3"	Yes	47065T278	7.95	47065T315	11.47
1 1/2"	4 1/2"	Yes	47065T279	9.16	47065T316	15.23
20mm	2 1/4"	Yes	5537T971	12.24	5537T282	12.58
30mm	3 3/8"	Yes	5537T972	15.42	5537T283	15.78
40mm	4 5/8"	Yes	5537T973	15.67	5537T284	16.09
45mm	5 1/8"	Yes	5537T974	16.18	5537T285	16.56
30° Angle						
1"	2 1/2"	Yes	47065T31	9.51	47065T379	10.54
1 1/2"	3 1/2"	Yes	47065T32	11.57	47065T393	12.61
40mm	3 5/8"	Yes	47065T948	11.96	—	—
45° Angle						
1"	2 3/4"	Yes	47065T306	9.78	47065T43	11.04
1 1/2"	4 1/2"	Yes	47065T309	11.99	47065T447	13.12
40mm	4 3/4"	Yes	47065T997	12.37	—	—
60° Angle						
1"	3"	Yes	47065T329	9.78	47065T464	12.14
1 1/2"	4 1/2"	Yes	47065T366	11.99	47065T467	13.34
40mm	4 3/4"	Yes	47065T998	12.37	—	—

Reducer Surface Brackets for Single Rails—Aluminum



Surface brackets connect rails without machining. Reducer surface brackets allow transitions between 1" and 1-1/2" height rails. The **offset-style reducer** has an offset to align the T-slots of the different-size rails.

Reducer Type	For Rail Ht.	Lg.	Mounting Fasteners Included	Silver	
				Part No.	Each
Straight	1", 1 1/2"	2 1/2"	Yes	47065T298	\$6.39
Offset	1", 1 1/2"	2 1/2"	Yes	47065T228	7.25

Braces for Single Rails—Aluminum

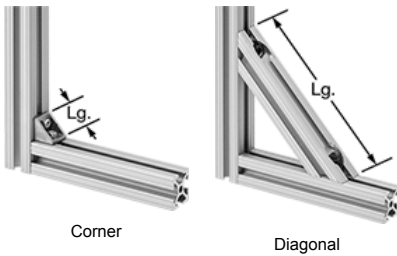

Braces create sturdier connections than brackets. They connect rails without machining. **Diagonal** braces add more support than corner braces.

For Rail Ht.	Lg.	Mounting Fasteners Included	Silver		Black	
			Each	Each	Each	Each
Corner						
1"	1"	Yes	47065T216	\$4.96	—	—
1 1/2", 40mm	2"	Yes	5537T51	7.98	—	—
20mm	1"	Yes	5537T81	5.39	—	—
45mm	2 1/4"	Yes	5537T196	8.28	—	—
Diagonal						
1"	6"	Yes	47065T186	14.36	47065T451	\$21.22
1"	12"	Yes	47065T188	15.43	47065T452	22.43
1"	18"	Yes	47065T701	16.80	47065T453	26.03
1"	24"	Yes	47065T703	19.82	47065T454	30.00
1 1/2"	6"	Yes	47065T12	16.00	47065T455	21.57
1 1/2"	12"	Yes	47065T27	19.91	47065T456	27.87
1 1/2"	18"	Yes	47065T702	20.84	47065T457	28.42
1 1/2"	24"	Yes	47065T704	22.77	47065T458	33.49
20mm	6"	Yes	5537T2	17.12	—	—
20mm	12"	Yes	5537T368	18.53	—	—
20mm	18"	Yes	5537T601	21.84	—	—
20mm	24"	Yes	5537T602	24.04	—	—
30mm	6"	Yes	5537T603	19.41	—	—
30mm	12"	Yes	5537T604	22.53	—	—
30mm	18"	Yes	5537T605	25.81	—	—
30mm	24"	Yes	5537T606	29.42	—	—
40mm	6"	Yes	5537T201	20.37	—	—
40mm	12"	Yes	5537T37	25.17	—	—
40mm	18"	Yes	5537T608	30.09	—	—
40mm	24"	Yes	5537T609	35.08	—	—
45mm	6"	Yes	5537T202	21.01	—	—
45mm	12"	Yes	5537T372	25.53	—	—
45mm	18"	Yes	5537T611	30.37	—	—
45mm	24"	Yes	5537T612	36.33	—	—

Diagonal Brace Ends for Single Rails—Zinc



(Connecting rail sold separately.)

Use diagonal brace ends to make a brace of any length—a connecting rail (sold separately) between the brace ends is required.

For Rail Ht.	Mounting Fasteners Included	Pkg. Qty.	Pkg.
1"	Yes	2	47065T331 \$16.30
1 1/2"	Yes	2	47065T332 19.77
20mm	Yes	2	5537T471 15.21
30mm	Yes	2	5537T472 19.88
40mm	Yes	2	5537T473 21.83
45mm	Yes	2	5537T474 23.13

End-Feed Fasteners

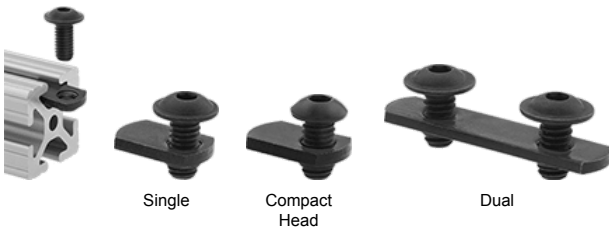

Single

Compact Head

Dual



Triple



Spring Tab

End-feed fasteners slide into the end of the rail to attach components. They consist of a screw and nut. Tighten the screw with a hex key. **Compact-head** fasteners are for use in tight spaces. **Dual** fasteners have two fastening points. **Triple** fasteners have three fastening points and can be used to attach large brackets. **Spring tab** fasteners align the nut flush with the T-slot opening.

Single	For Rail Ht.		Color	Material	Mounting Fastener		Pkg. Qty.	Pkg.
	Double and Quad	Triple			Thread Size	Thread Lg.		
Single								
1"	2"	3"	Black	Zinc-Plated Steel	1/4"-20	1/2"	4	47065T142 \$2.30
1 1/2"	3"	4 1/2"	—	302 Stainless Steel	5/16"-18	5/8"	4	47065T145 4.51
1 1/2"	3"	4 1/2"	Black	Zinc-Plated Steel	5/16"-18	11/16"	4	47065T97 2.71
20mm	40mm	—	—	304 Stainless Steel	M5	8mm	4	5537T457 4.27
20mm	40mm	—	Black	Zinc-Plated Steel	M5	8mm	4	5537T454 2.55
30mm	60mm	—	—	304 Stainless Steel	M6	16mm	4	5537T527 4.70
30mm	60mm	—	Black	Zinc-Plated Steel	M6	16mm	4	5537T867 2.87
40mm	80mm	—	—	304 Stainless Steel	M8	16mm	4	5537T458 5.05
40mm	80mm	—	Black	Zinc-Plated Steel	M8	16mm	4	5537T455 3.09
45mm	90mm	—	—	304 Stainless Steel	M8	16mm	4	5537T459 5.41
45mm	90mm	—	Black	Zinc-Plated Steel	M8	16mm	4	5537T456 3.33
Compact Head								
1"	2"	3"	Black	Zinc-Plated Steel	1/4"-20	1/2"	4	47065T139 1.85
1 1/2"	3"	4 1/2"	Black	Zinc-Plated Steel	5/16"-18	5/8"	4	47065T215 2.38
20mm	40mm	—	Black	Zinc-Plated Steel	M5	8mm	4	5537T161 1.99
30mm	60mm	—	Black	Zinc-Plated Steel	M6	16mm	4	5537T868 2.46
40mm	80mm	—	Black	Zinc-Plated Steel	M8	16mm	4	5537T162 2.49
45mm	90mm	—	Black	Zinc-Plated Steel	M8	16mm	4	5537T163 2.71
Dual								
1"	2"	3"	Black	Zinc-Plated Steel	1/4"-20	1/2"	4	47065T147 4.29
1 1/2"	3"	4 1/2"	Black	Zinc-Plated Steel	5/16"-18	11/16"	4	47065T149 6.76
20mm	40mm	—	Black	Zinc-Plated Steel	M5	8mm	4	5537T464 4.51
30mm	60mm	—	Black	Zinc-Plated Steel	M6	16mm	4	5537T869 5.24
40mm	80mm	—	Black	Zinc-Plated Steel	M8	16mm	4	5537T465 7.26
45mm	90mm	—	Black	Zinc-Plated Steel	M8	16mm	4	5537T466 8.04
Triple								
1"	2"	3"	Black	Zinc-Plated Steel	1/4"-20	1/2"	4	47065T991 6.99
1 1/2"	3"	4 1/2"	Black	Zinc-Plated Steel	5/16"-18	11/16"	4	47065T99 10.15
20mm	40mm	—	Black	Zinc-Plated Steel	M5	8mm	4	5537T425 5.71
30mm	60mm	—	Black	Zinc-Plated Steel	M6	16mm	4	5537T426 6.02
40mm	80mm	—	Black	Zinc-Plated Steel	M8	16mm	4	5537T427 8.31
45mm	90mm	—	Black	Zinc-Plated Steel	M8	16mm	4	5537T428 9.24
Each								
Spring Tab								
1"	2"	3"	—	Zinc-Plated Steel	1/4"-20	1/2"	—	47065T383 1.40

Drop-In Fasteners



with Handle



Spring-Loaded Ball



Spring Tab



with Stud

Drop-in fasteners can be placed directly into the T-slot to attach components—no need to disassemble your structure. They consist of a screw and nut. Fasteners **with a handle** are easy to grip and drop in place. Tighten with a hex key. **Spring-loaded ball** fasteners hold the nut in place. Tighten with a hex key. **Spring tab** fasteners align the nut flush with the T-slot opening. Tighten with a hex key. Fasteners **with stud** twist into place. Tighten with a socket wrench.

Single	For Rail Ht.		Color	Material	Handle Material	Mounting Fastener		Pkg. Qty.	Each
	Double and Quad	Triple				Thread Size	Thread Lg.		
With Handle									
1"	2"	3"	Black	Zinc-Plated Steel	Rubber	1/4"-20	1/2"	47065T151 \$2.27	
1 1/2"	3"	4 1/2"	Black	Zinc-Plated Steel	Rubber	5/16"-18	11/16"	47065T152 2.48	
20mm	40mm	—	Black	Zinc-Plated Steel	Rubber	M5	12mm	5537T246 2.15	
40mm	80mm	—	Black	Zinc-Plated Steel	Rubber	M6	12mm	5537T248 2.62	
40mm	80mm	—	Black	Zinc-Plated Steel	Rubber	M8	12mm	5537T249 2.62	
45mm	90mm	—	Black	Zinc-Plated Steel	Rubber	M8	16mm	5537T251 2.67	
Spring-Loaded Ball									
1"	2"	3"	—	Zinc-Plated Steel	—	1/4"-20	9/16"	47065T226 1.12	
1 1/2"	3"	4 1/2"	—	Zinc-Plated Steel	—	5/16"-18	11/16"	47065T327 1.21	
20mm	40mm	—	—	Zinc-Plated Steel	—	M5	8mm	5537T75 1.33	
40mm	80mm	—	—	Zinc-Plated Steel	—	M6	16mm	5537T41 1.40	
40mm	80mm	—	—	Zinc-Plated Steel	—	M8	16mm	5537T42 1.40	

For Rail Ht.		Triple	Color	Material	Handle Material	Mounting Fastener		Each
Single	Double and Quad					Thread Size	Thread Lg.	
Spring Tab								
1 1/2"	3"	4 1/2"	—	Zinc-Plated Steel	—	5/16"-18	11/16"	47065T229 1.46
30mm	60mm	—	—	Zinc-Plated Steel	—	M6	16mm	5537T541 1.49
40mm	80mm	—	—	Zinc-Plated Steel	—	M6	16mm	5537T262 1.49
40mm	80mm	—	—	Zinc-Plated Steel	—	M8	16mm	5537T263 1.49
45mm	90mm	—	—	Zinc-Plated Steel	—	M8	20mm	5537T264 1.52
With Stud								
1"	2"	3"	—	Zinc-Plated Steel	—	1/4"-20	1/2"	47065T233 1.52
1 1/2"	3"	4 1/2"	—	Zinc-Plated Steel	—	5/16"-18	31/32"	47065T234 1.58
30mm	60mm	—	—	Zinc-Plated Steel	—	M6	22mm	5537T268 1.62
40mm	80mm	—	—	Zinc-Plated Steel	—	M8	22mm	5537T269 1.62
45mm	90mm	—	—	Zinc-Plated Steel	—	M8	22mm	5537T271 1.76

Connectors



Straight (Slide into T-slot—no machining required.)



L-Shaped (Slide into T-slot—no machining required.)



Tee (Thread the connector directly into a T-slot and use the included fastener to secure.)



Concealed (Tap one hole to install the connector and drill one access hole in the mating rail to secure the connection.)

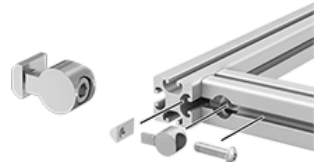

Anchor (Drill an installation hole in the face of one rail to install.)

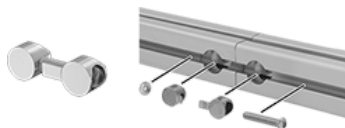

Double Anchor (Drill an installation hole in the face of each rail to install.)

Connectors mount internally rather than externally to provide a more finished appearance than brackets and braces.

Straight, L-shaped, and Tee connectors install without machining. **Straight** and **L-shaped** connectors slide into T-slots. **Tee** connectors thread directly into a T-slot and use the included fastener to secure.

Concealed connectors require one tapped hole to install the connector and one drilled access hole in the mating rail to secure the connection.

Anchor connectors allow positioning anywhere along the mating rail's T-slot. Drill an installation hole in the face of one rail to install.

Double-anchor connectors join rails end-to-end. Drill an installation hole in the face of each rail to install.

For Rail Ht.		Triple	Material	Mounting Fasteners Included	Each
Single	Double and Quad				
Straight					
1 1/2", 40mm	3", 80mm	4 1/2"	Zinc-Plated Steel	Yes	5537T294 \$6.30
30mm	60mm	—	Zinc-Plated Steel	Yes	5537T313 5.56
45mm	90mm	—	Zinc-Plated Steel	Yes	5537T278 7.50
L-Shaped					
1"	2"	3"	Zinc	Yes	5537T315 2.50
1 1/2", 30mm, 40mm	3", 60mm, 80mm	4 1/2"	Zinc	Yes	5537T316 3.56
45mm	90mm	—	Zinc	Yes	5537T323 4.10
Tee					
1 1/2"	3"	4 1/2"	Zinc-Plated Steel	Yes	47065T339 10.55
20mm	40mm	—	Zinc-Plated Steel	Yes	5537T326 6.96
30mm	60mm	—	Zinc-Plated Steel	Yes	5537T327 7.92
45mm	90mm	—	Zinc-Plated Steel	Yes	5537T328 9.12
Concealed					
1"	2"	3"	Zinc-Plated Steel	Yes	47065T155 1.79
1 1/2"	3"	4 1/2"	Zinc-Plated Steel	Yes	47065T156 1.91
20mm	40mm	—	Zinc-Plated Steel	Yes	5537T63 1.43
40mm	80mm	—	Zinc-Plated Steel	Yes	5537T33 2.20
45mm	90mm	—	Zinc-Plated Steel	Yes	5537T277 2.23
Anchor					
1"	2"	3"	Zinc	Yes	47065T153 3.39
1 1/2"	3"	4 1/2"	Zinc	Yes	47065T154 3.89
20mm	40mm	—	Zinc	Yes	5537T64 3.12
30mm	60mm	—	Zinc	Yes	5537T861 3.23
40mm	80mm	—	Zinc	Yes	5537T34 3.29
45mm	90mm	—	Zinc	Yes	5537T276 3.98

For Rail Ht.

Single	Double and Quad	Triple	Material	Mounting Fasteners Included	Each
Double Anchor					
1"	2"	3"	Zinc	Yes	47065T404 8.62
1 1/2"	3"	4 1/2"	Zinc	Yes	5537T272 8.62
20mm	40mm	—	Zinc	Yes	5537T273 5.52
40mm	80mm	—	Zinc	Yes	5537T274 6.36
45mm	90mm	—	Zinc	Yes	5537T275 7.24

Pivots for Single Rails

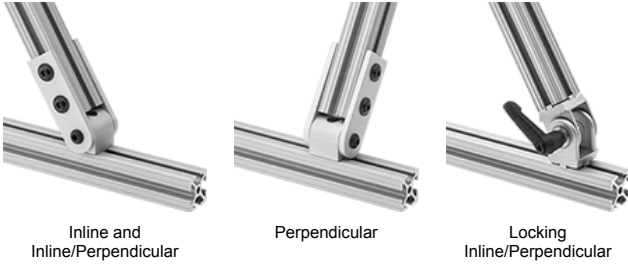

Pivots provide smooth motion at the junction between two rails to position rails. **Locking** pivots have a handle to lock in place.

For Rail Ht.	Pivot Style	Lg.	Color	Material	Handle Material	Mounting Fasteners Included	Each
Inline							
1"	Nonlocking	3"	Silver	Aluminum	—	Yes	47065T191 \$16.33
1 1/2"	Nonlocking	4 1/2"	Silver	Aluminum	—	Yes	47065T13 18.43
Perpendicular							
1"	Nonlocking	3"	Silver	Aluminum	—	Yes	47065T194 17.22
1 1/2"	Nonlocking	4 1/2"	Silver	Aluminum	—	Yes	47065T14 18.43
Inline/Perpendicular							
1"	Locking	—	Silver	Zinc	Plastic	Yes	47065T221 18.98
1 1/2"	Locking	—	Silver	Zinc	Plastic	Yes	47065T225 23.72
20mm	Locking	—	Silver	Aluminum	Plastic	Yes	5537T82 18.74
20mm	Nonlocking	2 3/8"	Silver	Aluminum	—	Yes	5537T219 20.03
30mm	Locking	—	Silver	Zinc	Plastic	Yes	5537T855 25.75
30mm	Nonlocking	3 5/8"	Silver	Aluminum	—	Yes	5537T865 22.30
40mm	Locking	—	Silver	Zinc	Plastic	Yes	5537T52 27.19
40mm	Nonlocking	4 3/4"	Silver	Aluminum	—	Yes	5537T221 23.46
45mm	Locking	—	Silver	Zinc	Plastic	Yes	5537T235 31.81
45mm	Nonlocking	5 1/2"	Silver	Aluminum	—	Yes	5537T222 24.07

Hinges for Single Rails

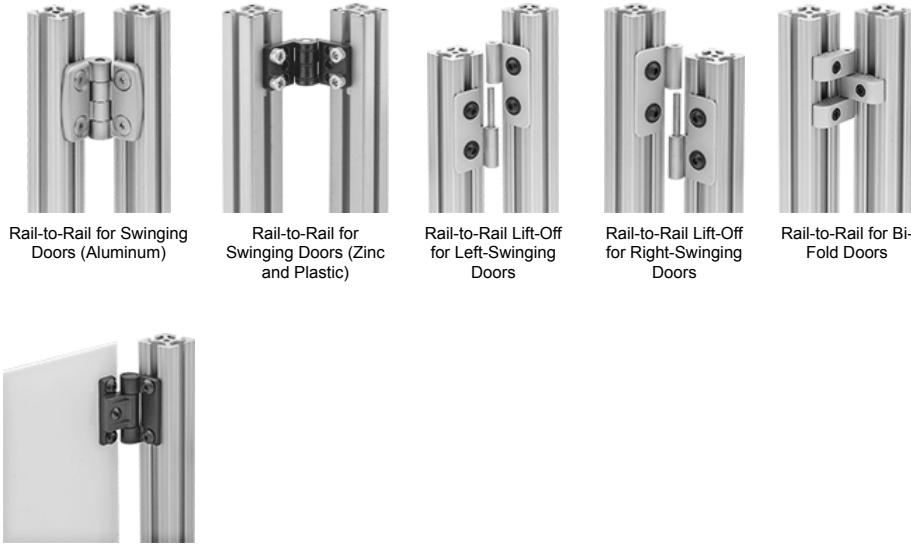

Rail-to-rail hinges provide smooth motion at the junction between two rails. Hinges with a **nonremovable pin** are reversible and can be used on left- and right-side doors. Hinges with a **lift-off pin** have a permanently attached pin for quickly lifting the door off the hinge without removing the pin. To choose a door mounting location, stand on the pull side of the door. Use a right-side hinge if the hinge is on the right. Use a left-side hinge if the hinge is on the left.

Rail-to-panel hinges provide smooth motion at the junction between a rail and a panel. They are reversible and can be used on left- and right-side doors.

For Rail Ht.	Color	Material	For Max. Panel Thick.	Mounting Fasteners Included	Each
Rail-to-Rail—For Swinging Doors					
Nonremovable Pin—Reversible					
1"	Silver	Aluminum	—	Yes	47065T951 \$20.57
1"	Black	Aluminum	—	Yes	47065T347 10.87
1 1/2"	Silver	Aluminum	—	Yes	47065T382 22.60
1 1/2"	Black	Aluminum	—	Yes	47065T348 14.25
20mm	Silver	Aluminum	—	Yes	5537T859 12.46
20mm	Black	Plastic	—	Yes	5537T85 4.76
30mm	Silver	Aluminum	—	Yes	5537T847 12.86
30mm	Black	Plastic	—	Yes	5537T858 7.04
40mm	Silver	Aluminum	—	Yes	5537T848 19.37
40mm	Black	Zinc	—	Yes	5537T55 16.58

For Rail Ht.	Color	Material	For Max. Panel Thick.	Mounting Fasteners Included	Each
45mm	Silver	Aluminum	—	Yes	5537T849 20.14
45mm	Black	Zinc	—	Yes	5537T332 17.10
Lift-Off Pin—Left Side					
1"	Silver	Aluminum	—	Yes	47065T345 9.91
1 1/2"	Silver	Aluminum	—	Yes	47065T346 18.87
Lift-Off Pin—Right Side					
1"	Silver	Aluminum	—	Yes	47065T343 9.91
1 1/2"	Silver	Aluminum	—	Yes	47065T344 18.87
Rail-to-Rail—For Bi-Fold Doors					
Nonremovable Pin—Reversible					
1"	Silver	Aluminum	—	Yes	47065T161 18.91
1 1/2"	Silver	Aluminum	—	Yes	47065T96 20.94
Rail-to-Panel—For Swinging Doors					
Nonremovable Pin—Reversible					
1"	Black	Plastic	1/4"	Yes	47065T162 9.15
1 1/2"	Black	Plastic	1/4"	Yes	47065T163 14.59
20mm	Black	Plastic	1/4"	Yes	5537T838 5.81
30mm	Black	Plastic	1/4"	Yes	5537T839 11.79
40mm	Black	Plastic	1/4"	Yes	5537T324 14.62
45mm	Black	Plastic	1/4"	Yes	5537T325 14.98

Tube Holders for Single Rails

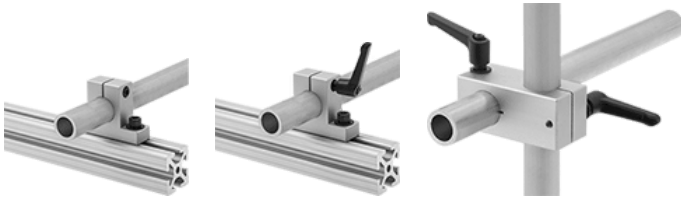

Rail-to-Tube Adjustable Rail-to-Tube Adjustable Tube-to-Tube

Tube holders attach tubes to a framing system (1" OD tube is sold separately). **Rail-to-tube** holders use a hex key to secure the tube in place. **Adjustable rail-to-tube** and **tube-to-tube** holders have a handle to secure the tube in place.

For Rail Ht.	For Tube OD	Color	Material	Handle Material	Mounting Fasteners Included	Each
Rail-to-Tube						
1"	1"	Silver	Aluminum	—	Yes	47065T205 \$34.10
1"	1"	Black	Aluminum	—	Yes	47065T301 36.24
1 1/2"	1"	Silver	Aluminum	—	Yes	47065T37 35.24
1 1/2"	1"	Black	Aluminum	—	Yes	47065T304 37.43
Adjustable Rail-to-Tube						
1"	1"	Silver	Aluminum	Plastic	Yes	47065T206 36.12
1"	1"	Black	Aluminum	Plastic	Yes	47065T302 38.27
1 1/2"	1"	Silver	Aluminum	Plastic	Yes	47065T41 37.27
1 1/2"	1"	Black	Aluminum	Plastic	Yes	47065T305 39.46
Adjustable Tube-to-Tube						
1", 1 1/2"	1"	Silver	Aluminum	Plastic	No	47065T24 63.47
1", 1 1/2"	1"	Black	Aluminum	Plastic	No	47065T303 66.49

Tube



For Rail Ht.	OD	ID	Lg., ft.	Material	Each
1", 1 1/2", 20mm, 30mm, 40mm, 45mm	1"	3/4"	4	Aluminum	47065T208 \$66.50

Mounting Plates



Rectangular Square Concealed

Rectangular and **square mounting plates** have room to drill mounting holes for attaching parts to T-slotted framing that are not sized to fit.

Concealed mounting plates slide inside the T-slot and have two mounting holes for attaching parts to T-slotted framing. When securing parts to the plate, the plate secures to the rail.

Single	For Rail Ht. Double and Quad	Triple	Wd.	Lg.	Thick.	Mounting Hole Center-to-Center	Material	Mounting Fasteners Included	Each
Silver									
Rectangular									
1"	2"	3"	2"	1"	3/16"	—	Aluminum	Yes	47065T851 \$11.16
1"	2"	3"	3"	1"	3/16"	—	Aluminum	Yes	47065T648 11.68
1 1/2"	3"	4 1/2"	3"	1 1/2"	1/4"	—	Aluminum	Yes	47065T853 12.14
1 1/2"	3"	4 1/2"	4"	1 1/2"	1/4"	—	Aluminum	Yes	47065T649 12.32
30mm	60mm	—	2 3/8"	1 1/8"	1/8"	—	Aluminum	Yes	5537T367 13.19
40mm	80mm	—	3 1/8"	1 5/8"	1/4"	—	Aluminum	Yes	5537T381 13.58
45mm	90mm	—	3 1/2"	1 3/4"	1/4"	—	Aluminum	Yes	5537T383 14.05
Square									
1"	2"	3"	2"	2"	3/16"	—	Aluminum	Yes	47065T852 11.32
1"	2"	3"	3"	3"	3/16"	—	Aluminum	Yes	47065T651 12.02
1 1/2"	3"	4 1/2"	3"	3"	1/4"	—	Aluminum	Yes	47065T854 12.56

Single	For Rail Ht.			Wd.	Lg.	Thick.	Mounting Hole Center-to-Center	Material	Mounting Fasteners Included	Each	
	Double and Quad	Triple	Mounting Hole Pattern Compatibility								
1 1/2"	3"	4 1/2"	4"	4"	1/4"	—	—	Aluminum	Yes	47065T652	13.71
30mm	60mm	—	2 3/8"	2 3/8"	1/8"	—	—	Aluminum	Yes	5537T386	13.59
40mm	80mm	—	3 1/8"	3 1/8"	1/4"	—	—	Aluminum	Yes	5537T382	14.09
45mm	90mm	—	3 1/2"	3 1/2"	1/4"	—	—	Aluminum	Yes	5537T384	15.09
Concealed											
1 1/2", 30mm, 40mm	3", 60mm, 80mm	4 1/2"	5/8"	6 5/16"	3/8"	2 3/8"	—	Aluminum	No	47065T641	15.40
1 1/2", 30mm, 40mm	3", 60mm, 80mm	4 1/2"	5/8"	8 11/16"	3/8"	2 3/8"	—	Aluminum	No	47065T642	19.94
1 1/2", 30mm, 40mm	3", 60mm, 80mm	4 1/2"	5/8"	11"	3/8"	2 3/8"	—	Aluminum	No	47065T643	24.45
Black Rectangular											
1"	2"	3"	2"	1"	3/16"	—	—	Aluminum	Yes	47065T644	11.13
1 1/2"	3"	4 1/2"	3"	1 1/2"	1/4"	—	—	Aluminum	Yes	47065T645	11.19
Square											
1"	2"	3"	2"	2"	3/16"	—	—	Aluminum	Yes	47065T646	11.54
1 1/2"	3"	4 1/2"	3"	3"	1/4"	—	—	Aluminum	Yes	47065T647	11.19

Monitor Mounts



Monitor mount has a VESA (Video Electronics Standards Association) standard mounting hole pattern.

Single	For Rail Ht.		Mounting Hole		Mounting		Each
	Double and Quad	Triple	Pattern Compatibility	Material	Fasteners Included		
1 1/2", 40mm	3", 80mm	4 1/2"	VESA 100, VESA 75	Plastic	Yes	47065T915	\$69.09

Sensor Holders



Sensor holders are compatible with laser sensors, photo eyes, and light-sensing switches.

Single	For Rail Ht.		For Sensor			Mounting		Each
	Double and Quad	Triple	OD	Color	Material	Fasteners Included		
1"	2"	3"	12 mm	Black	Plastic	Yes	5537T352	\$3.44
1"	2"	3"	18 mm	Black	Plastic	Yes	47065T351	3.82
30mm, 40mm	60mm, 80mm	—	12 mm	Black	Plastic	Yes	5537T341	3.44
30mm, 40mm	60mm, 80mm	—	18 mm	Black	Plastic	Yes	5537T881	3.82
45mm	90mm	—	12 mm	Black	Plastic	Yes	5537T342	3.44
45mm	90mm	—	18 mm	Black	Plastic	Yes	5537T882	3.82

Mounting Feet for Single Rails

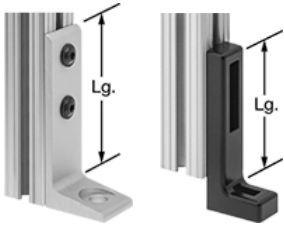

Fixed Height

Adjustable Height

Adjustable-height mounting feet mount to the rail and have an adjustment screw to allow height adjustment.

For Rail Ht.	Material	Lg.	Ht. Added	Mounting Fasteners Included	Silver		Black	
					Each	Each	Each	Each
Fixed Height								
1"	Aluminum	5"	—	Yes	47065T841	\$12.00	47065T711	\$11.85
1 1/2"	Aluminum	5"	—	Yes	47065T843	14.60	47065T713	14.62
20mm	Aluminum	5 1/2"	—	Yes	5537T411	10.54	5537T571	10.54
30mm	Aluminum	5 1/2"	—	Yes	5537T412	11.42	5537T572	11.42
40mm	Aluminum	5 1/2"	—	Yes	5537T413	12.85	5537T573	12.85
45mm	Aluminum	5 1/2"	—	Yes	5537T414	14.21	5537T574	14.21
Adjustable Height								
1 1/2"	Zinc	4 3/4"	0"-2"	Yes	—	—	47065T387	24.94
30mm	Zinc	4 3/4"	0"-2"	Yes	—	—	5537T295	22.00
40mm	Zinc	6 1/4"	0"-2 13/16"	Yes	—	—	5537T296	21.54
45mm	Zinc	6 1/4"	0"-2 13/16"	Yes	—	—	5537T297	21.54

Leveling Mounting Feet for Single Rails



Leveling mounting feet swivel 15° to compensate for uneven floors. One tapped hole is required for installation.

For Rail Ht.	Material	Lg.	Capacity	Stem Thread Size	Mounting Fasteners Included	Each
1"	Steel	2 1/16"	750 lbs.	1/4"-20	Yes	47065T341 \$6.19
1 1/2"	Steel	3"	2,800 lbs.	3/8"-16	Yes	47065T342 7.89
20mm	Steel	1 5/8"	515 lbs.	M6	Yes	5537T982 5.60
30mm, 40mm	Steel	2 1/16"	750 lbs.	M8	Yes	5537T983 6.19
45mm	Steel	3 1/4"	3,740 lbs.	M12	Yes	5537T984 11.57

Casters for Single Rails



Swivel casters swivel 360° and have a brake. Stem-mount swivel casters for single rails require one tapped hole for installation. Plate-mount swivel casters with 70-lb. capacity for single, double, and quad rails require two tapped holes for installation.

For Rail Ht.	Capacity	Color	Material	Wheel Dia.	Wheel Material	Stem Thread Size	Mounting Fasteners Included	Each
Fixed								
Plate Mount								
1 1/2", 40mm	265 lbs.	Silver	Steel	4"	Polyurethane Plastic	—	Yes	5537T437 \$38.40
45mm	265 lbs.	Silver	Steel	4"	Polyurethane Plastic	—	Yes	5537T438 38.40
Swivel								
Plate Mount								
1"	70 lbs.	Silver	Steel	2"	Rubber	3/8"-16	—	47065T83 15.98
1 1/2", 40mm	265 lbs.	Silver	Steel	4"	Polyurethane Plastic	—	Yes	5537T435 53.78
45mm	265 lbs.	Silver	Steel	4"	Polyurethane Plastic	—	Yes	5537T436 53.78
Stem Mount								
1 1/2"	125 lbs.	Silver	Steel	3"	Rubber	3/8"-16	—	47065T336 10.65
20mm	60 lbs.	Silver	Steel	50mm	Polypropylene Plastic	M6	—	5537T314 12.27
30mm, 40mm	85 lbs.	Silver	Steel	75mm	Polypropylene Plastic	M8	—	5537T317 20.18
45mm	110 lbs.	Silver	Steel	100mm	Polypropylene Plastic	M12	—	5537T318 30.69

Adjustable-Height Legs for Single Rails



Adjustable-height mounting feet mount to the rail and have an adjustment screw to allow height adjustment.

For Rail Ht.	Ht. Range	Lg.	Wd.	Color	Material	Includes	Each
1 1/2"	18"-24"	14"	4 1/2"	Silver, Blue	Aluminum	Components for 1 Leg: 1 1/2" Single Rail, 3" Quad Rail, Extended Mounting Foot, Guide Block, Locking Collar, Hardware	47065T248 \$203.89
1 1/2"	24"-36"	14"	4 1/2"	Silver, Blue	Aluminum	Components for 1 Leg: 1 1/2" Single Rail, 3" Quad Rail, Extended Mounting Foot, Guide Block, Locking Collar, Hardware	47065T297 221.22
1 1/2"	32"-48"	14"	4 1/2"	Silver, Blue	Aluminum	Components for 1 Leg: 1 1/2" Single Rail, 3" Quad Rail, Extended Mounting Foot, Guide Block, Locking Collar, Hardware	47065T299 244.32

Hydraulic Lift Kits for Single Rails

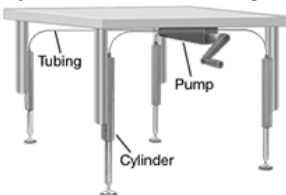

Hydraulic lift kits transform fixed-height T-slot workbenches into adjustable-height work surfaces. To install, attach each cylinder to a T-slot workbench leg with fasteners. Then, mount the pump under the workbench top and connect the cylinders to the pump with the included tubing. Use the hand crank to adjust the workbench height.

For Rail Ht.	For Min. Leg Ht.	Ht. Added	Material	Includes	Each
1 1/2"	19 1/4"	1 5/8"-13 5/8"	Aluminum	4 Lift Cylinders, 8 T-Slot Mounting Brackets, Hydraulic Pump with Hand Crank, Hydraulic Tubing, Mounting Fasteners	47065T352 \$774.56
1 1/2"	23 1/4"	1 5/8"-17 5/8"	Aluminum	4 Lift Cylinders, 8 T-Slot Mounting Brackets, Hydraulic Pump with Hand Crank, Hydraulic Tubing, Mounting Fasteners	47065T789 811.25

End Caps for Single Rails



End caps protect the ends of rails from damage and keep out dust and grime.

For Rail Ht.	Color	Material	Part No.	Each
Snap On				
1"	Black	Plastic	47065T91	\$1.20
1 1/2"	Black	Plastic	47065T87	1.50
20mm	Black	Plastic	5537T14	.98
40mm	Black	Plastic	5537T24	1.73
45mm	Black	Plastic	5537T302	1.86

Covers

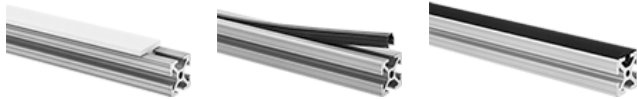

Wear Strip

Dust

Antislip

Wear strip covers are abrasion-resistant inserts that are slippery to reduce friction and increase sliding action along a T-slot.

Dust covers conceal wires and keep dust out of the T-slot. Cut covers to size with scissors and press them into a T-slot. Flip the black dust covers over and they have a groove for holding a panel inside the T-slot.

Antislip cover adds traction to the surface of a rail. Insert it into the T-slot.

Single	For Rail Ht.		Lg., ft.	Material	Choose a Color	Each
	Double and Quad	Triple				
Wear Strip						
1"	2"	3"	6	UHMW Plastic	White	47065T5 \$48.89
1 1/2"	3"	4 1/2"	3	UHMW Plastic	White	47065T837 33.22
1 1/2"	3"	4 1/2"	6	UHMW Plastic	White	47065T839 58.20
40mm	80mm	—	3	UHMW Plastic	White	5537T523 33.22
40mm	80mm	—	6	UHMW Plastic	White	5537T526 58.20
Dust Cover						
1"	2"	3"	6	Plastic	Black, Blue, Gray, Orange, Red, Yellow	47065T93 4.15
1 1/2"	3"	4 1/2"	6	Plastic	Black, Blue, Gray, Orange, Red, Yellow	47065T4 4.27
20mm	40mm	—	6	Plastic	Black	5537T15 3.90
30mm, 40mm	60mm, 80mm	—	6	Plastic	Black, Gray, Yellow	5537T319 4.30
45mm	90mm	—	6	Plastic	Black, Gray, Yellow	5537T322 4.37
Antislip						
1 1/2", 40mm	3", 80mm	4 1/2"	6	Santoprene Rubber	Black	47065T721 17.88

Seals



Inline Bulb

Offset Bulb

Brush

Bulb and brush seals cover door gaps to keep out air and dust. Press them into a T-slot.

Single	For Rail Ht.		Lg.	Bulb Ht.	Offset	Bristle Lg.	Color	Material	Each
	Double and Quad	Triple							
Inline Bulb									
1 1/2"	3"	4 1/2"	72"	0.313"	—	—	Black	Rubber	47065T814 \$8.56
Offset Bulb									
30mm	60mm	—	79"	0.25"	7/8"	—	Gray	PVC Plastic	5537T897 13.84
45mm	90mm	—	79"	0.25"	1 1/8"	—	Gray	PVC Plastic	5537T898 15.40
Brush									
1 1/2", 40mm	3", 80mm	4 1/2"	39 3/8"	—	—	1 9/16"	Black	Nylon Plastic	47065T911 17.12

Panel Gaskets

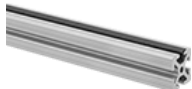

Panel gaskets keep out liquid and dust while holding panels securely in place. Press them into a T-slot.

Single	For Rail Ht.		Lg.	Color	Material	Each
	Double and Quad	Triple				
1 1/2", 30mm, 40mm	3", 60mm, 80mm	4 1/2"	78 3/4"	Black	Rubber	5537T871 \$8.68
45mm	90mm	—	78 3/4"	Black	Rubber	5537T872 12.90

Panels for Single, Double, Triple, and Quad Rails

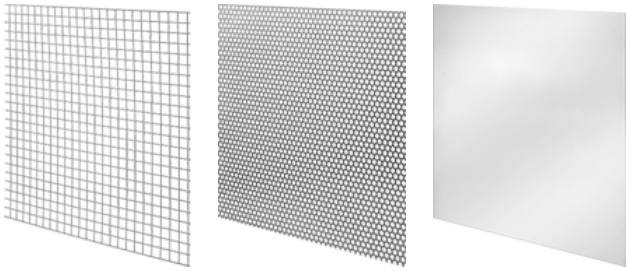

Mesh

Perforated

Solid
Opening

Lg., ft.	Wd., ft.	Color	Material	Wire Thick.	Wire Dia.	Wire Dia.	Lg.	Wd.	Each	
Mesh										
2	2	Black	Steel	—	1/8"	—	1"	1"	47065T287	\$13.67
2	2	Yellow	Steel	—	1/8"	—	1"	1"	47065T292	23.53
4	2	Black	Steel	—	1/8"	—	1"	1"	47065T288	27.35
4	2	Yellow	Steel	—	1/8"	—	1"	1"	47065T293	35.71
4	4	Black	Steel	—	1/8"	—	1"	1"	47065T289	54.70
4	4	Yellow	Steel	—	1/8"	—	1"	1"	47065T294	59.53
8	4	Black	Steel	—	1/8"	—	1"	1"	47065T291	88.55
8	4	Yellow	Steel	—	1/8"	—	1"	1"	47065T295	97.43
Perforated										
2	2	Silver	Aluminum	1/8"	—	3/8"	—	—	47065T901	66.48
4	2	Silver	Aluminum	1/8"	—	3/8"	—	—	47065T902	133.00
4	4	Silver	Aluminum	1/8"	—	3/8"	—	—	47065T903	267.72
8	4	Silver	Aluminum	1/8"	—	3/8"	—	—	47065T904	533.63
Solid										
2	2	Clear	Acrylic Plastic	1/4"	—	—	—	—	47065T321	40.96
2	2	Clear	Polycarbonate Plastic	1/4"	—	—	—	—	47065T325	52.15
4	2	Clear	Acrylic Plastic	1/4"	—	—	—	—	47065T322	69.72
4	2	Clear	Polycarbonate Plastic	1/4"	—	—	—	—	47065T326	88.08
4	4	Clear	Acrylic Plastic	1/4"	—	—	—	—	47065T323	125.23
4	4	Clear	Polycarbonate Plastic	1/4"	—	—	—	—	47065T333	162.16
8	4	Clear	Acrylic Plastic	1/4"	—	—	—	—	47065T324	208.76
8	4	Clear	Polycarbonate Plastic	1/4"	—	—	—	—	47065T334	293.61

Panel Hangers

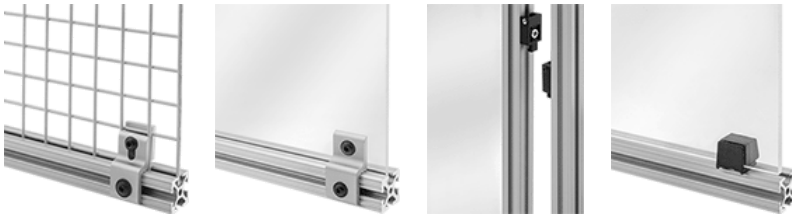

Screw On for Mesh Panels

Screw On for Solid Panels

Lift Off

Twist On

Lift-off panel hangers can be easily removed for access.

Twist-on panel hangers twist into a T-slot and don't require fasteners.

Single	For Rail Ht. Double and Quad	Triple	Panel Hanger Style	For Max. Panel Thick.	Color	Material	Mounting Fasteners Included	Each
For Mesh Panels								
Screw On								
1"	2"	3"	Rail-to-Panel	—	Silver	Aluminum	Yes	47065T197 \$5.68
1 1/2"	3"	4 1/2"	Rail-to-Panel	—	Silver	Aluminum	Yes	47065T198 6.68
20mm	40mm	—	Rail-to-Panel	—	Silver	Aluminum	Yes	5537T305 5.87
30mm	60mm	—	Rail-to-Panel	—	Silver	Aluminum	Yes	5537T841 7.50
40mm	80mm	—	Rail-to-Panel	—	Silver	Aluminum	Yes	5537T306 7.82
45mm	90mm	—	Rail-to-Panel	—	Silver	Aluminum	Yes	5537T307 8.20
For Solid Panels								
Screw On								
1"	2"	3"	Rail-to-Panel	—	Silver	Aluminum	Yes	47065T195 4.95
1 1/2"	3"	4 1/2"	Rail-to-Panel	—	Silver	Aluminum	Yes	47065T196 5.66
20mm	40mm	—	Rail-to-Panel	—	Silver	Aluminum	Yes	5537T308 4.88
30mm	60mm	—	Rail-to-Panel	—	Silver	Aluminum	Yes	5537T842 6.10
40mm	80mm	—	Rail-to-Panel	—	Silver	Aluminum	Yes	5537T309 6.34
45mm	90mm	—	Rail-to-Panel	—	Silver	Aluminum	Yes	5537T311 6.71
Lift Off								
1", 30mm	2", 60mm	3"	Rail-to-Rail	—	Black	Zinc	Yes	5537T845 9.56
1 1/2"	3"	4 1/2"	Rail-to-Rail	—	Black	Zinc	Yes	5537T415 8.64
40mm, 45mm	80mm, 90mm	—	Rail-to-Rail	—	Black	Zinc	Yes	5537T416 8.64
Twist On								
1"	2"	3"	Rail-to-Panel	1/4"	Black	Plastic	—	47065T251 2.35
1 1/2"	3"	4 1/2"	Rail-to-Panel	3/8"	Black	Plastic	—	47065T252 2.39
20mm	40mm	—	Rail-to-Panel	1/4"	Black	Plastic	—	5537T87 2.31
30mm	60mm	—	Rail-to-Panel	1/4"	Black	Plastic	—	5537T843 2.44
40mm	80mm	—	Rail-to-Panel	3/16"	Black	Plastic	—	5537T57 2.54
45mm	90mm	—	Rail-to-Panel	3/16"	Black	Plastic	—	5537T312 2.79

Panel Slides

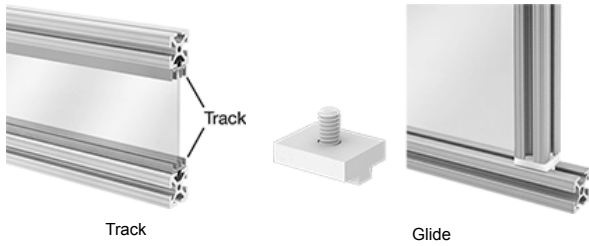

Panel slide tracks include a top and bottom track that snap into T-slots and don't require fasteners. They allow panels to slide smoothly along the track after the frame is assembled.

Panel slide glides attach to the end of a rail to allow panels to travel smoothly along a T-slot. They also rotate 360° to allow the panel to pivot. The panel (sold separately) fits in the T-slot of the sliding rail.

For Rail Ht.				For Max. No. of Panels	For Max. Panel Thick.	Color	Finish	Material	Mounting Fasteners Included	Each
Single	Double and Quad	Triple	Lg.							
Track										
1"	2"	3"	48"	2	1/4"	Silver	Anodized	Aluminum	—	47065T166 \$23.88
1 1/2"	3"	4 1/2"	48"	3	1/4"	Silver	Anodized	Aluminum	—	47065T78 28.75
40mm	80mm	—	48"	3	1/4"	Silver	Anodized	Aluminum	—	5537T321 32.38
Glide										
1"	2"	3"	1"	1	—	White	—	Plastic	Yes	47065T3 2.89
1 1/2"	3"	4 1/2"	1 1/2"	1	—	White	—	Plastic	Yes	47065T75 4.01

Rail Slides

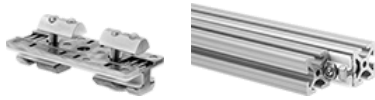

Rail slides allow one rail to slide along another. They can be used to build drawers into systems.

For Rail Ht.				Material				Mounting Fasteners Included	Each
Single	Double and Quad	Lg.	Wd.	Color	Carriage	Liner	Includes		
40mm	80mm	3 1/8"	1 1/4"	Gray	Zinc	Acetal Plastic	Two Carriages with Liners	Yes	5537T293 \$44.40

Roller Wheels



Roller wheels can be used to roll frames, panels, and other components along the length of the T-slot.

For Rail Ht.					Material	Mounting Fasteners Included	Each
Single	Double and Quad	Triple	Color	Color			
1"	2"	3"	Black	Black	Plastic	Yes	47065T204 \$15.76
1 1/2"	3"	4 1/2"	Black	Black	Plastic	Yes	47065T63 26.90
20mm	40mm	—	Black	Black	Plastic	Yes	5537T353 9.80
30mm, 40mm	60mm, 80mm	—	Black	Black	Plastic	Yes	5537T354 10.05
45mm	90mm	—	Black	Black	Plastic	Yes	5537T355 10.32

Cable Holders

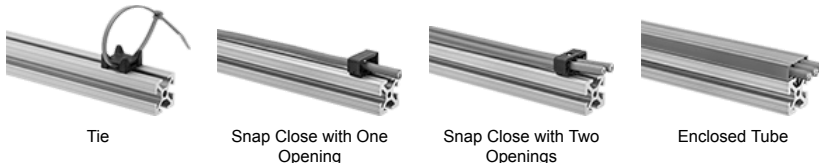

Cable tie holders accept cable ties (not included) to keep cable and tube organized. They twist into a T-slot.

Snap-close cable holders keep cable and tube organized while allowing easy access. They twist into a T-slot.

Enclosed-tube cable holder hides and protects cable and tube. Press it into a T-slot.

Single	For Rail Ht.			No. of Openings	For Max. Cable Tie				Projection	Color	Material	Mounting Fasteners Included	Each
	Double and Quad	Triple	For Max. Cable Wd.		Thick.	Wd.	Lg.	Wd.					
Tie													
1"	2"	3"	1	—	1/16"	3/8"	—	—	—	Black	Plastic	—	47065T268 \$0.72
1 1/2"	3"	4 1/2"	1	—	1/16"	3/8"	—	—	—	Black	Plastic	—	47065T217 1.79
20mm	40mm	—	1	—	1/16"	3/8"	—	—	—	Black	Plastic	—	5537T356 1.14
40mm	80mm	—	1	—	1/16"	3/8"	—	—	—	Black	Plastic	—	47065T219 1.79
45mm	90mm	—	1	—	1/16"	3/8"	—	—	—	Black	Plastic	—	5537T357 1.88
Snap Close													
1"	2"	3"	1	1 1/16"	—	—	—	—	—	Black	Plastic	Yes	47065T386 3.00
1"	2"	3"	2	7/16"	—	—	—	—	—	Black	Plastic	Yes	47065T389 3.83
1 1/2"	3"	4 1/2"	1	1 1/16"	—	—	—	—	—	Black	Plastic	Yes	47065T388 3.00
1 1/2"	3"	4 1/2"	2	7/16"	—	—	—	—	—	Black	Plastic	Yes	47065T6 4.50
20mm	40mm	—	1	1 1/16"	—	—	—	—	—	Black	Plastic	Yes	5537T834 3.00
20mm	40mm	—	2	7/16"	—	—	—	—	—	Black	Plastic	Yes	5537T851 3.83
30mm	60mm	—	1	1 1/16"	—	—	—	—	—	Black	Plastic	Yes	5537T835 3.00

Single	For Rail Ht.		Triple	No. of Openings	For Max. Cable Wd.	For Max. Cable Tie				Projection	Color	Material	Mounting Fasteners Included	Each	
	Double and Quad					Thick.	Wd.	Lg.	Wd.						
30mm	60mm		2	2	7/16"	—	—	—	—	—	Black	Plastic	Yes	5537T852	3.83
40mm	80mm		1	1	1 1/16"	—	—	—	—	—	Black	Plastic	Yes	5537T836	3.00
40mm	80mm		2	2	7/16"	—	—	—	—	—	Black	Plastic	Yes	5537T853	3.83
45mm	90mm		1	1	1 1/16"	—	—	—	—	—	Black	Plastic	Yes	5537T837	3.00
45mm	90mm		2	2	7/16"	—	—	—	—	—	Black	Plastic	Yes	5537T854	3.83
Enclosed Tube															
1 1/2", 30mm, 40mm	3", 60mm, 80mm	4 1/2"	3	3	3/8"	—	—	78"	1 9/16"	5/8"	Silver	Plastic	—	5537T227	37.92

Wire Duct

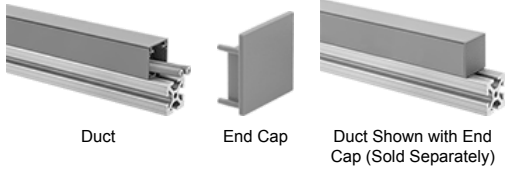

Wire duct routes cables, wires, and hoses.

Wire duct end caps mount to the ends of conduit to keep out dust and grime.

For Rail Ht.									
Single	Lg.	Wd.	Ht.	Color	Material	Mounting Fasteners Included		Each	
Duct									
1 1/2", 40mm	118"	40mm	40mm	Gray	PVC Plastic	Yes		5537T909	\$104.44
End Cap									
1 1/2", 40mm	—	40mm	40mm	Gray	Fiberglass-Reinforced Plastic	—		5537T996	2.36

Latches



Push-to-close latches have a handle to open. Keyed push-to-close latches are keyed alike. Choose these latches if you need several that open with the same key. Release knob for push-to-close latches offers a means of escape if a door latch closes with someone inside an enclosure.

Single	For Rail Ht.		Triple	Color	Material	For Max. Panel Thick.	Key No.	No. of Keys Included	Mounting Fasteners Included	Each	
	Double and Quad										
Magnetic											
1", 1 1/2"	2", 3"	3", 4 1/2"		Silver	Aluminum	3/16"	—	—	Yes	47065T165	\$7.26
20mm	40mm	—		Black	Plastic	3/16"	—	—	Yes	5537T86	8.28
30mm	60mm	—		Black	Plastic	3/16"	—	—	Yes	5537T417	8.28
40mm	80mm	—		Black	Plastic	3/16"	—	—	Yes	5537T56	9.20
45mm	90mm	—		Black	Plastic	3/16"	—	—	Yes	5537T229	9.41
Slide-Bolt											
1", 1 1/2"	2", 3"	3", 4 1/2"		Silver	Aluminum	—	—	—	Yes	47065T57	20.95
20mm	40mm	—		—	Zinc	—	—	—	Yes	5537T337	19.58
30mm	60mm	—		—	Zinc	—	—	—	Yes	5537T418	19.58
40mm	80mm	—		—	Zinc	—	—	—	Yes	5537T393	21.21
45mm	90mm	—		—	Zinc	—	—	—	Yes	5537T394	21.66
Nonlocking Push-to-Close											
1 1/2", 40mm	3", 80mm	4 1/2"		Black	Aluminum	—	—	—	Yes	5537T535	33.70
30mm	60mm	—		Black	Aluminum	—	—	—	Yes	5537T534	33.70
45mm	90mm	—		Black	Aluminum	—	—	—	Yes	5537T537	33.70
Keyed Push-to-Close											
1 1/2", 40mm	3", 80mm	4 1/2"		Black	Aluminum	—	0813437	2	Yes	5537T532	37.76
30mm	60mm	—		Black	Aluminum	—	0813437	2	Yes	5537T531	37.76
45mm	90mm	—		Black	Aluminum	—	0813437	2	Yes	5537T533	37.76
Release Knob for Push-to-Close Latches											
1 1/2", 40mm	3", 80mm	4 1/2"		Black	Plastic	—	—	—	Yes	5537T539	15.78
30mm	60mm	—		Black	Plastic	—	—	—	Yes	5537T538	15.78
45mm	90mm	—		Black	Plastic	—	—	—	Yes	5537T555	15.78

Door Stops

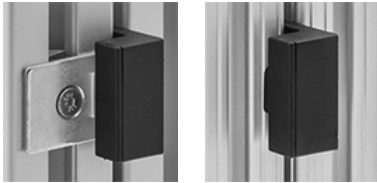

Magnetic

Rubber Bumper

Door stops require a gap so doors will close properly. The gap is the distance between the door and the frame when the door is closed. **Magnetic** door stops hold a door closed with magnets. **Rubber-bumper** door stops prevent a closing door from banging into its frame.

For Rail Ht.

Single	Double and Quad	Color	Material	Required Door Gap	Mounting Fasteners Included	Each
Magnetic						
40mm	80mm	Black	Plastic	3/16"-1/4"	Yes	5537T395 \$16.56
45mm	90mm	Black	Plastic	3/16"-1/4"	Yes	5537T396 16.56
Rubber Bumper						
40mm	80mm	Black	Plastic	3/16"-1/4"	Yes	5537T397 13.68
45mm	90mm	Black	Plastic	3/16"-1/4"	Yes	5537T398 13.68

Handles



Pull

Sure-Grip Pull

Offset Sure-Grip Pull

Sure-grip pull handles have finger indentations.

Offset sure-grip pull handles have a curved design; they are good for tight spaces and double doors.

For Rail Ht.

Single	Double and Quad	Triple	Lg.	Color	Projection	Mounting Fasteners Included	Each
Pull							
Plastic							
1"	2"	3"	4 7/16"	Black	1 7/16"	Yes	47065T164 \$6.40
1"	2"	3"	4 7/16"	Red	1 7/16"	Yes	47065T595 7.21
1 1/2"	3"	4 1/2"	4 1/2"	Black	1 5/8"	Yes	47065T54 7.52
1 1/2"	3"	4 1/2"	5 1/2"	Red	1 5/8"	Yes	47065T596 11.00
20mm	40mm	—	5 3/16"	Black	1 5/8"	Yes	5537T84 7.72
30mm	60mm	—	5 3/16"	Black	1 5/8"	Yes	5537T419 7.72
Aluminum							
1", 1 1/2"	2", 3"	3", 4 1/2"	5 1/4"	Silver	2 1/16"	Yes	47065T592 26.77
1", 1 1/2"	2", 3"	3", 4 1/2"	5 1/4"	Black	2 1/16"	Yes	47065T591 28.49
1", 1 1/2"	2", 3"	3", 4 1/2"	7 3/16"	Silver	2 1/4"	Yes	47065T594 28.49
1", 1 1/2"	2", 3"	3", 4 1/2"	7 3/16"	Black	2 1/4"	Yes	47065T593 29.94
Sure-Grip Pull							
Plastic							
20mm	40mm	—	5 5/8"	Black	1 7/8"	Yes	5537T623 9.32
30mm	60mm	—	7 3/8"	Black	2 3/8"	Yes	5537T624 10.78
40mm	80mm	—	9 7/16"	Black	2 15/16"	Yes	5537T629 13.26
40mm, 45mm	80mm, 90mm	—	7 3/8"	Black	2 3/8"	Yes	5537T54 8.38
45mm	90mm	—	9 7/16"	Black	2 15/16"	Yes	5537T647 13.26
Offset Sure-Grip Pull							
Plastic							
30mm	60mm	—	9 7/16"	Black	3 1/8"	Yes	5537T648 31.40
40mm	80mm	—	9 7/16"	Black	3 1/8"	Yes	5537T649 31.40
45mm	90mm	—	9 7/16"	Black	3 1/8"	Yes	5537T65 31.40

Tool Holders

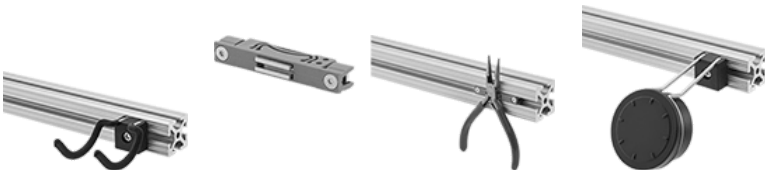

Hook

Magnetic

Magnetic Arm



Hook and Loop



Open Bottom



Closed Bottom

Magnetic tool holder mounts inside the rail to hold small ferrous objects.

Magnetic-arm tool holders mount to the rail and have raised bumps to keep small ferrous objects in place.

Hook-and-loop tool holders come with two pieces to hold lightweight objects. One piece is hook and mounts to the rail. The other piece is adhesive-back loop and mounts to the object. Secure the two pieces together to store the object on the rail.

For Rail Ht.

Single	Double and Quad	Triple	Color	Material	Mounting Fasteners Included	Each
Hook						
1 1/2", 40mm	3", 80mm	4 1/2"	Black	Steel	Yes	47065T914 \$17.94
Magnetic						
1 1/2", 40mm	3", 80mm	4 1/2"	—	Steel	Yes	5537T696 19.37
Magnetic Arm						
1 1/2", 40mm	3", 80mm	4 1/2"	Black	Steel	Yes	47065T913 65.89
Hook and Loop						
1 1/2", 40mm	3", 80mm	4 1/2"	Black	Plastic	Yes	47065T2 0.82
Open Bottom						
1"	2"	3"	Black	Plastic	Yes	47065T247 14.95
1 1/2", 40mm, 45mm	3", 80mm, 90mm	4 1/2"	Black	Plastic	Yes	47065T273 15.81
20mm, 30mm	40mm, 60mm	—	Black	Plastic	Yes	5537T226 14.68
Closed Bottom						
1 1/2", 40mm	3", 80mm	4 1/2"	Black	Plastic	Yes	5537T809 81.31

Hangers



Hangers slide into T-slots and suspend items such as air tools, cable reels, and panels.

For Rail Ht.

Single	Double and Quad	Triple	Color	Material	Each
1"	2"	3"	Black	Plastic	47065T203 \$8.68
1 1/2"	3"	4 1/2"	Black	Plastic	47065T22 11.16
20mm	40mm	—	Black	Plastic	5537T362 3.70
30mm, 40mm	60mm, 80mm	—	Black	Plastic	5537T363 4.33
45mm	90mm	—	Black	Plastic	5537T364 4.55

Shelves



Shelves keep workstations, carts, and bin structures organized. They snap into the rail.

For Rail Ht.

Single	Double and Quad	Triple	Wd.	Ht.	Projection	Color	Material	Each
1 1/2"	3"	4 1/2"	12"	3"	6"	Black	Steel	47065T583 \$51.46
1 1/2"	3"	4 1/2"	24"	3"	12"	Black	Steel	47065T584 114.00

Bin Box Holders



Bin box holders allow you to hang any storage bin with a lip on a rail.

For Rail Ht.

Single	Double and Quad	Triple	Lg.	Color	Material	Mounting Fasteners Included	Each
1", 1 1/2"	2", 3"	3", 4 1/2"	6"	Silver	Aluminum	Yes	47065T8 \$7.08
1", 1 1/2"	2", 3"	3", 4 1/2"	12"	Silver	Aluminum	Yes	47065T9 8.47
40mm	80mm	—	6"	Silver	Aluminum	Yes	5537T521 7.72
40mm	80mm	—	12"	Silver	Aluminum	Yes	5537T522 9.25

Trays



Trays keep workstations, carts, and bin structures organized. They snap into the rail.

For Rail Ht.		Double and Quad	Triple	Lg.	Wd.	Ht.	Material	Features	Choose a Color	Each
Single	1 1/2", 30mm, 40mm	3", 60mm, 80mm	4 1/2"	—	4 1/8"	1 15/16"	Plastic	Label Holder	Black, Gray, Green, Red, Yellow	5537T652 \$5.93
	1 1/2", 30mm, 40mm	3", 60mm, 80mm	4 1/2"	4 3/8"	4 5/16"	1 9/16"	Plastic	—	Black	5537T683 8.13
	1 1/2", 30mm, 40mm	3", 60mm, 80mm	4 1/2"	8 1/4"	8 1/4"	1 9/16"	Plastic	—	Black	5537T685 13.36
	45mm	90mm	—	—	4 1/8"	1 15/16"	Plastic	Label Holder	Black, Gray, Green, Red, Yellow	5537T672 5.93
	45mm	90mm	—	4 3/8"	4 5/16"	1 9/16"	Plastic	—	Black	5537T684 8.13
	45mm	90mm	—	8 1/4"	8 1/4"	1 9/16"	Plastic	—	Black	5537T686 13.36

Baskets



Baskets keep workstations, carts, and bin structures organized. They snap into the rail.

For Rail Ht.		Double and Quad	Triple	Wd.	Ht.	Projection	Color	Material	Features	Each
Single	1 1/2"	3"	4 1/2"	8 3/8"	3 3/8"	4 7/8"	Black	Steel	Label Holder	47065T581 \$80.64
	1 1/2"	3"	4 1/2"	14"	4"	8"	Black	Steel	—	47065T582 108.35

Label Holders



Label holders keep workstations, carts, and bin structures organized. They snap into the rail.

For Rail Ht.		Double and Quad	Lg.	Ht.	Color	Material	Each
Single	30mm	60mm	4"	1 1/8"	Gray	PVC Plastic	5537T993 \$1.55
	40mm, 45mm	80mm, 90mm	4"	1 9/16"	Gray	PVC Plastic	5537T994 1.90
	40mm, 45mm	80mm, 90mm	6 5/16"	1 9/16"	Gray	PVC Plastic	5537T995 2.98

Flanged Sleeve Bearing Carriages for Single Rails

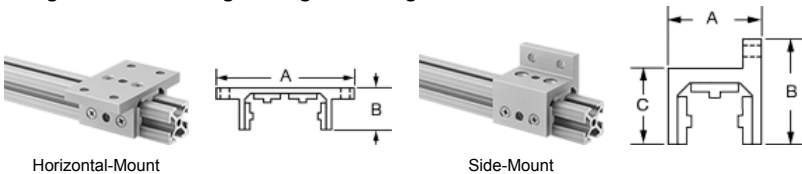

Sleeve bearing carriages are for linear motion applications. They have through holes to allow fastening from the top of your load into the carriage as well as from the bottom of the carriage into your load. They can handle dirt, water, impact, and vibration. **High-strength** sleeve bearing carriages are good for pick-and-place, parts-transfer, and other high-speed applications with frequent starts and stops. **Bearing pads** replace worn pads in sleeve bearing and high-strength sleeve bearing carriages. **Hand brakes** hold sleeve bearing carriages in place on the rail. Drill a hole in high-strength carriages to mount. Standard carriages have a mounting hole for the brakes.

For Rail Ht.	Static Load Capacity	Carriages					Carriage Material	Mounting Fasteners Included	Each	Bearing Pads		Hand Brakes	
		Lg.	(A)	(B)	(C)	Each				Each	Each		
Horizontal-Mount													
Standard Strength													
1"	90 lbs.	1 7/8"	2 15/16"	1 1/4"	—	Aluminum	No	47065T959	\$46.16	47065T771	\$2.14	60585K31	\$10.77
1"	90 lbs.	4"	2 15/16"	1 1/4"	—	Aluminum	No	47065T961	59.41	47065T771	2.14	60585K31	10.77
1 1/2"	90 lbs.	2 13/16"	4"	1 7/8"	—	Aluminum	No	47065T962	58.00	47065T772	2.82	60585K32	15.50
1 1/2"	90 lbs.	6"	4"	1 7/8"	—	Aluminum	No	47065T963	75.02	47065T772	2.82	60585K32	15.50
40mm	90 lbs.	75mm	103mm	50mm	—	Aluminum	No	5537T643	58.00	5537T631	2.82	60585K99	15.50
40mm	120 lbs.	160mm	103mm	50mm	—	Aluminum	No	5537T644	75.02	5537T631	2.82	60585K99	15.50
45mm	270 lbs.	80mm	109mm	54mm	—	Aluminum	No	5537T991	130.09	—	—	60585K59	62.00
45mm	540 lbs.	160mm	109mm	54mm	—	Aluminum	No	5537T992	168.18	—	—	60585K59	62.00
High Strength													
1 1/2"	90 lbs.	2 13/16"	4"	1 7/8"	—	Aluminum	No	47065T968	70.74	47065T773	4.28	60585K32	15.50
1 1/2"	90 lbs.	6"	4"	1 7/8"	—	Aluminum	No	47065T969	87.76	47065T773	4.28	60585K32	15.50
Side-Mount													
Standard Strength													
1"	90 lbs.	1 7/8"	1 5/8"	2"	1 5/16"	Aluminum	No	47065T953	43.51	47065T771	2.14	60585K31	10.77
1"	90 lbs.	4"	1 5/8"	2"	1 5/16"	Aluminum	No	47065T954	55.86	47065T771	2.14	60585K31	10.77
1 1/2"	90 lbs.	2 13/16"	2 1/2"	2 3/4"	2"	Aluminum	No	47065T955	55.35	47065T772	2.82	60585K32	15.50
1 1/2"	90 lbs.	6"	2 1/2"	2 3/4"	2"	Aluminum	No	47065T956	71.47	47065T772	2.82	60585K32	15.50
40mm	90 lbs.	75mm	65mm	72mm	53mm	Aluminum	No	5537T641	55.35	5537T631	2.82	60585K99	15.50
40mm	90 lbs.	160mm	65mm	72mm	53mm	Aluminum	No	5537T642	71.47	5537T631	2.82	60585K99	15.50
High Strength													
1 1/2"	90 lbs.	2 13/16"	2 1/2"	2 3/4"	2"	Aluminum	No	47065T957	68.09	47065T773	4.28	60585K32	15.50
1 1/2"	90 lbs.	6"	2 1/2"	2 3/4"	2"	Aluminum	No	47065T958	84.21	47065T773	4.28	60585K32	15.50

Standard Sleeve Bearing Carriages for Single Rails

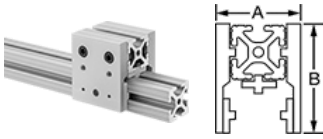

Sleeve bearing carriages are for linear motion applications. They have through holes to allow fastening from the top of your load into the carriage as well as from the bottom of the carriage into your load. They can handle dirt, water, impact, and vibration. **Bearing pads** replace worn pads in sleeve bearing and high-strength sleeve bearing carriages. **Hand brakes** hold sleeve bearing carriages in place on the rail. Standard carriages have a mounting hole for the brakes.

For Rail Ht.	Static Load Capacity	Lg.	Carriages			Carriage Material	Mounting Fasteners Included	Each	Bearing Pads for Side		Bearing Pads for Top		Hand Brakes	
			(A)	(B)	(C)				Each	Each	Each	Each		
Side-Mount														
Standard Strength														
1"	90 lbs.	1 7/8"	1 5/8"	2 1/16"	Aluminum	No	47065T778	\$38.50	47065T774	\$2.31	47065T776	\$3.38	60585K31	\$10.77
1"	120 lbs.	4"	1 5/8"	2 1/16"	Aluminum	No	47065T783	50.78	47065T774	2.31	47065T776	3.38	60585K31	10.77
1 1/2"	90 lbs.	2 13/16"	2 1/2"	3 1/8"	Aluminum	No	47065T781	50.33	47065T775	3.33	47065T777	3.95	60585K32	15.50
1 1/2"	120 lbs.	6"	2 1/2"	3 1/8"	Aluminum	No	47065T785	66.45	47065T775	3.33	47065T777	3.95	60585K32	15.50
40mm	90 lbs.	75mm	66mm	79mm	Aluminum	No	5537T634	50.33	5537T632	3.33	5537T633	3.95	60585K99	15.50
40mm	120 lbs.	160mm	66mm	79mm	Aluminum	No	5537T636	66.45	5537T632	3.33	5537T633	3.95	60585K99	15.50

Track Roller Carriages for Single Rails

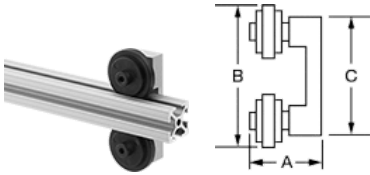

Track roller carriages are for applications that don't require high precision, such as creating sliding door frames, glides, and track systems. Multiple track roller carriages can be used on a rail.

For Rail Ht.	Dynamic Load Capacity	Material			Roller Dia.	Bearing	Carriage	Roller	Lubrication	Mounting Fasteners Included	Each	
		(A)	(B)	(C)								
1"	25 lbs.	1 5/16"	3 5/8"	3 1/8"	1 1/2"	Bronze	Aluminum	Nylon Plastic	Lubricated	Yes	47065T973	\$56.67
1 1/2"	25 lbs.	1 7/8"	5 1/8"	4 5/8"	2"	Bronze	Aluminum	Nylon Plastic	Lubricated	Yes	47065T974	64.17
40mm	25 lbs.	49mm	137mm	123mm	54mm	Bronze	Aluminum	Nylon Plastic	Lubricated	Yes	5537T638	58.34

Strip Doors



Strip doors are sized to fit short openings and allow in/out access while keeping dirt, dust, and debris out. They snap into the rail.

Wd.	Ht.	For Rail Ht.			Strips		Color	Material	Each	
		Single	Double and Quad	Triple	No. of	Thick.				
36"	36"	1"	2"	3"	9	0.06"	4"	Clear PVC Plastic	47065T481	\$81.10
48"	36"	1"	2"	3"	12	0.06"	4"	Clear PVC Plastic	47065T485	82.70
48"	48"	1"	2"	3"	12	0.06"	4"	Clear PVC Plastic	47065T561	90.80
60"	36"	1"	2"	3"	15	0.06"	4"	Clear PVC Plastic	47065T823	84.30
60"	60"	1"	2"	3"	15	0.06"	4"	Clear PVC Plastic	47065T865	100.50

Positioning Arms



With AMPS-Compatible Mounting Plate

With Hand-Held Device Grip

Positioning arms have ball-and-socket connections for 360° positioning. They have handles to lock joints into position.

Single	For Rail Ht.			Arm Lg.	Each
	Double and Quad	Triple	Arm Lg.		
With AMPS-Compatible Mounting Plate					
1", 1 1/2", 30mm, 40mm, 45mm	2", 3", 60mm, 80mm, 90mm	3", 4 1/2"	3 1/2"	47065T361	\$57.23
With Hand-Held Device Grip					
1", 1 1/2", 30mm, 40mm, 45mm	2", 3", 60mm, 80mm, 90mm	3", 4 1/2"	5 1/4"	47065T371	68.20

Outlet Strips



Outlet strips mount to T-slotted framing to bring electrical power to workstations and other structures.

Single Aluminum	For Rail Ht.		Total No. of Outlets	Cord Lg.	Cord Lg.	Plug End		Socket End		Current	Voltage	Specifications Met	Mounting Fasteners Included	Each
	Double and Quad	Triple				Gender	NEMA Style	Gender	NEMA Style					
1", 1 1/2", 30mm, 40mm	2", 3", 60mm, 80mm	3", 4 1/2"	8	6 ft.	20"	Male	5-15	Female	5-15	15A	120V AC	UL Listed	Yes	47065T763 \$64.02

Hole-Making Jigs for Single Rails



Hole-making jigs are templates for aligning and drilling accurate holes in rails. Mount the jig to the rail where holes are necessary, drill the holes, remove the jig, and reuse.

For Rail Ht.	For No. of Holes	Hole Dia.	Material		Each
1"	1	0.201"	Aluminum	47065T448	\$23.45
1 1/2"	1	0.281"	Aluminum	47065T696	25.70
1 1/2"	2	0.281"	Aluminum	47065T729	43.12
2"	2	0.201"	Aluminum	47065T482	40.81