

INSTRUCTION MANUAL



SR50A, SR50A-316SS,
and SR50AH
Sonic Ranging Sensors

Revision: 10/16



Copyright © 2007-2016
Campbell Scientific, Inc.

Limited Warranty

“Products manufactured by CSI are warranted by CSI to be free from defects in materials and workmanship under normal use and service for twelve months from the date of shipment unless otherwise specified in the corresponding product manual. (Product manuals are available for review online at www.campbellsci.com.) Products not manufactured by CSI, but that are resold by CSI, are warranted only to the limits extended by the original manufacturer. Batteries, fine-wire thermocouples, desiccant, and other consumables have no warranty. CSI’s obligation under this warranty is limited to repairing or replacing (at CSI’s option) defective Products, which shall be the sole and exclusive remedy under this warranty. The Customer assumes all costs of removing, reinstalling, and shipping defective Products to CSI. CSI will return such Products by surface carrier prepaid within the continental United States of America. To all other locations, CSI will return such Products best way CIP (port of entry) per Incoterms ® 2010. This warranty shall not apply to any Products which have been subjected to modification, misuse, neglect, improper service, accidents of nature, or shipping damage. This warranty is in lieu of all other warranties, expressed or implied. The warranty for installation services performed by CSI such as programming to customer specifications, electrical connections to Products manufactured by CSI, and Product specific training, is part of CSI’s product warranty. **CSI EXPRESSLY DISCLAIMS AND EXCLUDES ANY IMPLIED WARRANTIES OF MERCHANTABILITY OR FITNESS FOR A PARTICULAR PURPOSE. CSI hereby disclaims, to the fullest extent allowed by applicable law, any and all warranties and conditions with respect to the Products, whether express, implied or statutory, other than those expressly provided herein.**”

Assistance

Products may not be returned without prior authorization. The following contact information is for US and international customers residing in countries served by Campbell Scientific, Inc. directly. Affiliate companies handle repairs for customers within their territories. Please visit www.campbellsci.com to determine which Campbell Scientific company serves your country.

To obtain a Returned Materials Authorization (RMA), contact CAMPBELL SCIENTIFIC, INC., phone (435) 227-9000. Please write the issued RMA number clearly on the outside of the shipping container. Campbell Scientific's shipping address is:

CAMPBELL SCIENTIFIC, INC.

RMA# _____
815 West 1800 North
Logan, Utah 84321-1784

For all returns, the customer must fill out a "Statement of Product Cleanliness and Decontamination" form and comply with the requirements specified in it. The form is available from our website at www.campbellsci.com/repair. A completed form must be either emailed to repair@campbellsci.com or faxed to (435) 227-9106. Campbell Scientific is unable to process any returns until we receive this form. If the form is not received within three days of product receipt or is incomplete, the product will be returned to the customer at the customer's expense. Campbell Scientific reserves the right to refuse service on products that were exposed to contaminants that may cause health or safety concerns for our employees.

Safety

DANGER — MANY HAZARDS ARE ASSOCIATED WITH INSTALLING, USING, MAINTAINING, AND WORKING ON OR AROUND TRIPODS, TOWERS, AND ANY ATTACHMENTS TO TRIPODS AND TOWERS SUCH AS SENSORS, CROSSARMS, ENCLOSURES, ANTENNAS, ETC. FAILURE TO PROPERLY AND COMPLETELY ASSEMBLE, INSTALL, OPERATE, USE, AND MAINTAIN TRIPODS, TOWERS, AND ATTACHMENTS, AND FAILURE TO HEED WARNINGS, INCREASES THE RISK OF DEATH, ACCIDENT, SERIOUS INJURY, PROPERTY DAMAGE, AND PRODUCT FAILURE. TAKE ALL REASONABLE PRECAUTIONS TO AVOID THESE HAZARDS. CHECK WITH YOUR ORGANIZATION'S SAFETY COORDINATOR (OR POLICY) FOR PROCEDURES AND REQUIRED PROTECTIVE EQUIPMENT PRIOR TO PERFORMING ANY WORK.

Use tripods, towers, and attachments to tripods and towers only for purposes for which they are designed. Do not exceed design limits. Be familiar and comply with all instructions provided in product manuals. Manuals are available at www.campbellsci.com or by telephoning (435) 227-9000 (USA). You are responsible for conformance with governing codes and regulations, including safety regulations, and the integrity and location of structures or land to which towers, tripods, and any attachments are attached. Installation sites should be evaluated and approved by a qualified engineer. If questions or concerns arise regarding installation, use, or maintenance of tripods, towers, attachments, or electrical connections, consult with a licensed and qualified engineer or electrician.

General

- Prior to performing site or installation work, obtain required approvals and permits. Comply with all governing structure-height regulations, such as those of the FAA in the USA.
- Use only qualified personnel for installation, use, and maintenance of tripods and towers, and any attachments to tripods and towers. The use of licensed and qualified contractors is highly recommended.
- Read all applicable instructions carefully and understand procedures thoroughly before beginning work.
- Wear a **hardhat** and **eye protection**, and take **other appropriate safety precautions** while working on or around tripods and towers.
- **Do not climb** tripods or towers at any time, and prohibit climbing by other persons. Take reasonable precautions to secure tripod and tower sites from trespassers.
- Use only manufacturer recommended parts, materials, and tools.

Utility and Electrical

- **You can be killed** or sustain serious bodily injury if the tripod, tower, or attachments you are installing, constructing, using, or maintaining, or a tool, stake, or anchor, come in **contact with overhead or underground utility lines**.
- Maintain a distance of at least one-and-one-half times structure height, 20 feet, or the distance required by applicable law, **whichever is greater**, between overhead utility lines and the structure (tripod, tower, attachments, or tools).
- Prior to performing site or installation work, inform all utility companies and have all underground utilities marked.
- Comply with all electrical codes. Electrical equipment and related grounding devices should be installed by a licensed and qualified electrician.

Elevated Work and Weather

- Exercise extreme caution when performing elevated work.
- Use appropriate equipment and safety practices.
- During installation and maintenance, keep tower and tripod sites clear of un-trained or non-essential personnel. Take precautions to prevent elevated tools and objects from dropping.
- Do not perform any work in inclement weather, including wind, rain, snow, lightning, etc.

Maintenance

- Periodically (at least yearly) check for wear and damage, including corrosion, stress cracks, frayed cables, loose cable clamps, cable tightness, etc. and take necessary corrective actions.
- Periodically (at least yearly) check electrical ground connections.

WHILE EVERY ATTEMPT IS MADE TO EMBODY THE HIGHEST DEGREE OF SAFETY IN ALL CAMPBELL SCIENTIFIC PRODUCTS, THE CUSTOMER ASSUMES ALL RISK FROM ANY INJURY RESULTING FROM IMPROPER INSTALLATION, USE, OR MAINTENANCE OF TRIPODS, TOWERS, OR ATTACHMENTS TO TRIPODS AND TOWERS SUCH AS SENSORS, CROSSARMS, ENCLOSURES, ANTENNAS, ETC.

Table of Contents

PDF viewers: These page numbers refer to the printed version of this document. Use the PDF reader bookmarks tab for links to specific sections.

1. Introduction	1
2. Precautions	1
3. Initial Inspection.....	1
4. QuickStart.....	2
5. Overview.....	4
6. Specifications.....	5
7. Installation.....	7
7.1 Sensor Mounting.....	7
7.1.1 Beam Angle.....	7
7.1.2 Mounting Height.....	7
7.1.2.1 Reference Point.....	8
7.1.3 Mounting Options.....	8
7.2 SDI-12 Wiring.....	10
7.3 SDI-12 Programming.....	10
7.3.1 SDI12Recorder() Instruction.....	11
8. Operation.....	11
8.1 Quality Numbers.....	12
8.2 Temperature Compensation.....	12
8.3 SDI-12 Measurements.....	13
8.3.1 SDI-12 Addresses.....	13
8.3.2 SDI-12 Commands.....	13
9. Maintenance and Troubleshooting.....	15
9.1 Disassembly/Assembly Procedures.....	15
9.2 Data Interpretation and Filtering.....	18
9.2.1 Data Interpretation.....	18
9.2.2 Data Filtering.....	18

Appendices

A. Importing Short Cut Code Into CRBasic Editor ...	A-1
B. Example Programs.....	B-1
B.1 SDI-12 Example Programs.....	B-1
B.1.1 CR1000 SDI-12 Program.....	B-1

B.1.2	CR6 SDI-12 Program.....	B-3
B.2	RS-232 Example Programs	B-6
B.2.1	CR1000 RS-232 Program.....	B-6
B.3	RS-485 Example Programs	B-9
B.3.1	CR1000 Programming Example Using an MD485 and SC110 9-pin Male Connector	B-9
B.3.2	CR6 RS-485 Programming Example	B-13
B.4	Heater Program Examples.....	B-16
C. Jumper Settings		C-1
D. RS-232 and RS-485 Operation.....		D-1
D.1	RS-232 Operation.....	D-1
D.1.1	RS-232 Wiring	D-1
D.2	RS-485 Operation.....	D-2
D.2.1	RS-485 Wiring Using a MD485.....	D-3
D.3	RS-485 Wiring to a CR6 Datalogger.....	D-4
D.4	RS-232 and RS-485 Settings.....	D-4
D.4.1	Baud Rate Setting.....	D-6
D.4.2	Address.....	D-7
D.4.3	Operational Mode Setting	D-7
D.3.3.1	Measure in Poll Mode.....	D-7
D.3.3.2	Auto Measure Auto Output Mode	D-7
D.3.3.3	Auto Measure Polled Output Mode	D-7
D.4.4	Distance to Target or Depth	D-8
D.4.5	Distance to Ground	D-8
D.4.6	Measurement Interval Units.....	D-8
D.4.7	Measurement Interval Value	D-8
D.4.8	Output Unit	D-9
D.4.9	Quality Output.....	D-9
D.4.10	Diagnostics Output.....	D-9
D.5	Serial Commands	D-9
D.5.1	Setup Command.....	D-9
D.5.2	Poll Command.....	D-9
D.5.3	Information Command	D-9
D.5.4	Temperature Input Command	D-10
D.6	RS-232/RS-485 Data Output Format	D-10
D.6.1	Measurement Output.....	D-10
D.6.2	Information Message Output.....	D-12
E. Tera Term QuickStart.....		E-1
E.1	Configure <i>Tera Term</i> for Serial 9600 BPS Communication	E-1
E.2	Firmware Update.....	E-5
E.2.1	Configure <i>Tera Term</i> to Send SR50A/T Firmware Update	E-5
E.2.2	Sending New Firmware to a SR50A/T Sensor.....	E-6
F. SR50AH Heater Operation		F-1
F.1	Heater Specifications.....	F-1
F.1.2	Heating Cable Requirements.....	F-1
F.2	Heater Maintenance.....	F-2

Figures

7-1.	Beam Angle Clearance.....	7
7-2.	Distance from Edge of Transducer Housing to Grill	8
7-3.	SR50A Mounted to a Crossarm via the 19517 Mounting Kit	9
7-4.	Another Angle of the 19517 Mounting Kit.....	9
7-5.	SR50A Mounted to a 19484 Mounting Stem.....	9
7-6.	SR50A-316SS Mounted to a Crossarm with the 19484 and Nu-Rail Fitting	10
9-1.	Disconnect Cable from Sensor.....	15
9-2.	Remove Six Screws from the Transducer Housing.....	16
9-3.	Remove Transducer Housing and Disconnect Wires.....	16
9-4.	Location of Desiccant in Transducer Housing Assembly	17
9-5.	Remove and Replace Desiccant.....	17
9-6.	Remove the Two Flat Phillips Screws to Expose the PCB	18
C-1.	Jumper Settings	C-1
D-1.	RS-232 DB9 Connector Description.....	D-1
D-2.	SR50A to MD485 Wiring	D-3
D-3.	Initial Terminal Window in <i>Device Configuration Utility</i>	D-5
D-4.	SR50A Setup Menu	D-5
E-1.	<i>Tera Term</i> New Connection.....	E-1
E-2.	Setup Selections	E-2
E-3.	Terminal Configuration.....	E-2
E-4.	Windows Setup Changes	E-3
E-5.	Setting the Font Size	E-3
E-6.	Configuring the Serial Port	E-4
E-7.	Testing the Configuration	E-4
E-8.	Configuring the Com Port to Send an Operating System.....	E-6
E-9.	Jumper Settings.....	E-6
F-1.	SR50AH Heater Option	F-2
F-2.	Complete Transducer Assembly with Power Connection.....	F-4

Tables

7-1.	Wire Color, Function, and Datalogger Connection.....	10
8-1.	Quality Number Description	12
8-2.	SDI-12 Commands.....	13
B-1.	Wiring for CR1000 and CR6 SDI-12 Example Programs	B-1
B-2.	Wiring for CR1000 and CR6 RS-232 Example Programs	B-6
B-3.	14291 Field Power Cable Connections	B-9
B-4.	107 and SC110 Wiring for CR1000 RS-232 Example Program.....	B-9
B-5.	SR50A (Configured for MD485) Wiring to MD485 (9-pin connector plugged into MD485 RS-232 port)	B-10
B-6.	Wiring for CR6 RS-485 Program	B-13
B-7.	Wiring for CR1000 and CR6 Heater Example Programs	B-16
D-1.	SR50A RS-232 Interface Wiring	D-2
D-2.	SR50A Datalogger COM Port Wiring	D-2
D-3.	Connections for RS-485 Mode.....	D-3
D-4.	Connections for CR6 RS-485 Mode	D-4
D-5.	RS-232 and RS-485 Settings.....	D-6

CRBasic Examples

B-1.	CR1000 SDI-12 Program.....	B-1
B-2.	CR6 SDI-12 Program.....	B-3
B-3.	CR1000 RS-232 Program	B-6

B-4.	CR1000 Programming Example Using an MD485 and SC110 9-pin Male Connector	B-10
B-5.	CR6 RS-485 Programming Example	B-13
B-6.	CR1000 Heater Program Example	B-16
B-7.	CR6 Heater Program Example	B-19

SR50A-Series Sonic Ranging Sensor

1. Introduction

The SR50A, SR50A-316SS, and SR50AH are sonic ranging sensors that provide a non-contact method for determining snow or water depth. They determine depth by emitting an ultrasonic pulse and then measuring the elapsed time between the emission and return of the pulse. An air temperature measurement is required to correct for variations of the speed of sound in air.

Differences between the SR50A, SR50A-316SS, and SR50AH:

- SR50A: standard anodized aluminum body
- SR50A-316SS: marine grade 316L stainless steel body with a parylene-coated transducer head
- SR50AH: standard anodized aluminum body with a heated transducer head to prevent riming

NOTE

This manual provides information only for CRBasic dataloggers. It is also compatible with our retired Edlog dataloggers. For Edlog datalogger support, see an older manual at www.campbellsci.com/old-manuals.

2. Precautions

- READ AND UNDERSTAND the *Safety* section at the front of this manual.
- Never open the sensor while it is connected to power or any other device.
- Always disconnect the sensor using the connector or disconnect the cable wires from their termination points.
- Never operate the sensor with the shield wire disconnected. The shield wire plays an important role in noise emissions and susceptibility as well as transient protection.
- Follow local regulations (see Compliance in Section 6, *Specifications (p. 5)*).

3. Initial Inspection

- Upon receipt of the sensor, inspect the packaging for any signs of shipping damage and, if found, report the damage to the carrier in accordance with policy. The contents of the package should also be inspected and a claim filed if any shipping related damage is discovered.

4. QuickStart

Short Cut is an easy way to program your datalogger to measure the SR50A and assign datalogger wiring terminals. *Short Cut* is available as a download on www.campbellsci.com and the *ResourceDVD*. It is included in installations of *LoggerNet*, *PC200W*, *PC400*, or *RTDAQ*.

Use the following procedure to get started.

NOTES

A temperature measurement is required. For this tutorial, the 107-L thermistor is used.

1. Open *Short Cut*. Click **New Program**.

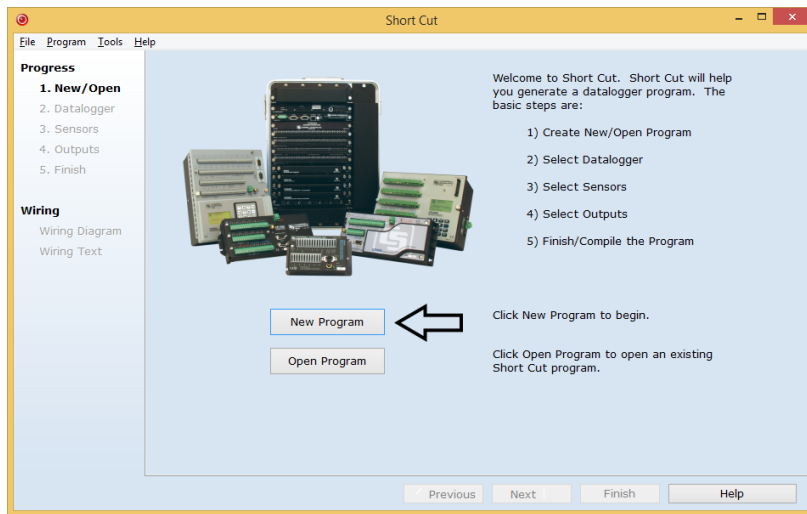

2. Select **Datalogger Model** and **Scan Interval** (60 second or higher scan interval is recommended). Click **Next**.

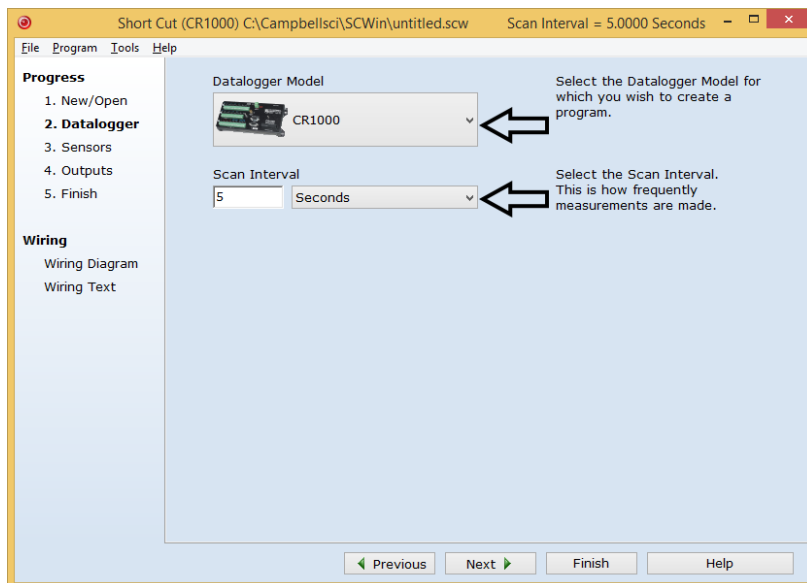

- Under the **Available Sensors and Devices** list, select the **Sensors | Temperature** folder. Select **107 Temperature Probe**. Click to  move the selection to the **Selected** device window. Use the data default of degree Celsius.

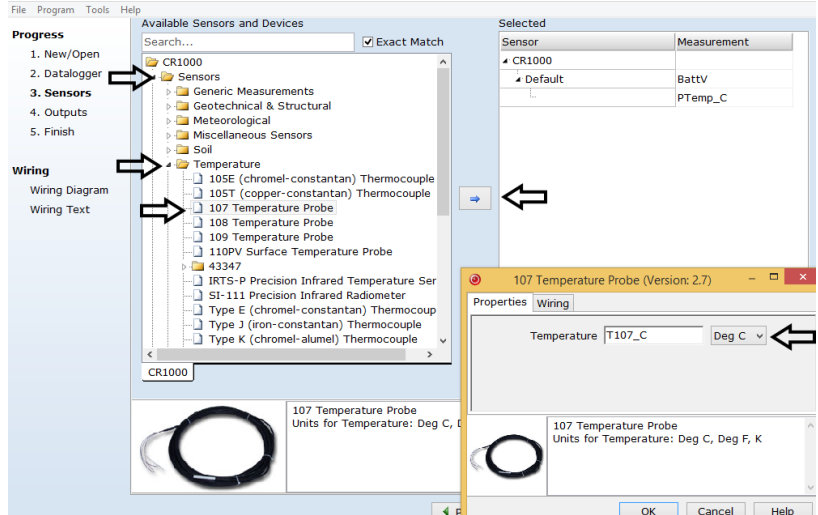

- Under the **Available Sensors and Devices** list, select the **Sensors | Miscellaneous Sensors** folder. Select **SR50A Sonic Ranging Sensor (SDI-12 Output)**. Click  to move the selection to the **Selected** device window. Data defaults to meters, which can be changed by clicking the **Unit of measure** box and selecting **cm, ft, or in**. Enter the **Distance to base**, which is the distance from the SR50A's wire mesh face to the ground. **SDI-12 Address** defaults to 0. Enter the correct **SDI-12 Address** for the SR50A if it has been changed from the factory-set default value. Click on the **Air temperature (Deg C) reference** box and select **T107_C**.

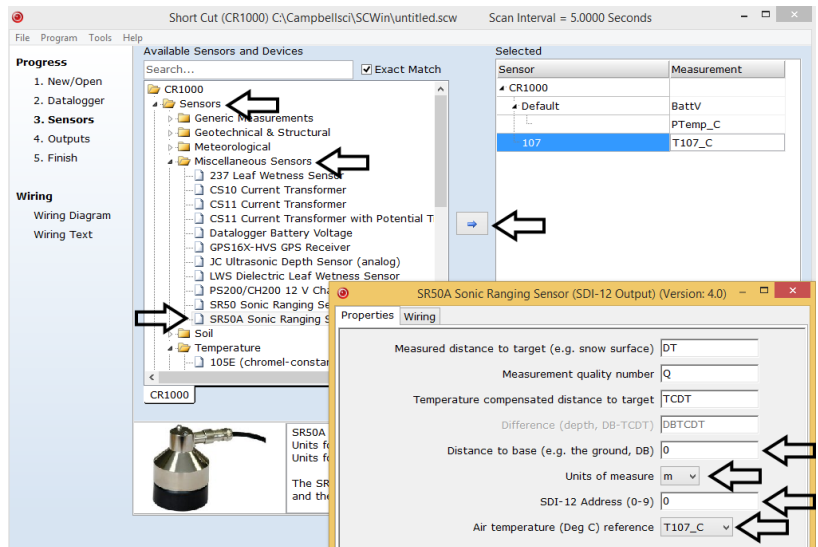

- After selecting the sensors, click **Wiring Diagram** to see how the sensor is to be wired to the datalogger. The wiring diagram can be printed now or after more sensors are added.

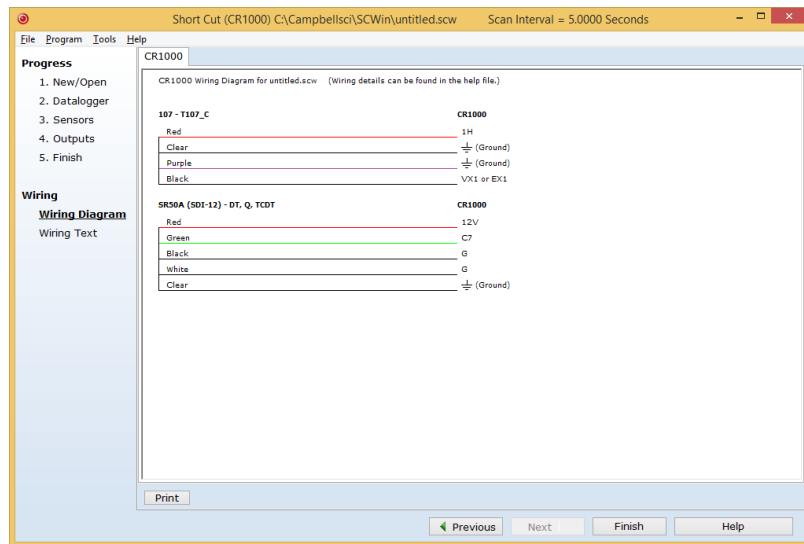

- Select any other sensors you have, then finish the remaining *Short Cut* steps to complete the program. The remaining steps are outlined in *Short Cut Help*, which is accessed by clicking on **Help | Contents | Programming Steps**.
- If *LoggerNet*, *PC200W*, *PC400*, or *RTDAQ* is running on your PC, and the PC to datalogger connection is active, you can click **Finish** in *Short Cut* and you will be prompted to send the program just created to the datalogger.
- If the sensor is connected to the datalogger, as shown in the wiring diagram in step 5, check the output of the sensor in the datalogger support software data display to make sure it is making reasonable measurements.

5. Overview

The SR50A-series sensors measure the distance from the sensor to a target. They determine the distance to a target by sending out ultrasonic pulses (50 kHz) and listening for the returning echoes that are reflected from the target. The time from transmissions to return of the echo is the basis for obtaining the distance measurement.

Since the speed of sound in air varies with temperature, an independent temperature measurement is required to compensate the distance reading for these sensors. A simple calculation is applied to initial readings for this purpose.

The SR50A-series sensors are capable of picking up small targets or targets that are highly absorptive to sound, such as low density snow. They use a unique echo-processing algorithm to help ensure measurement reliability. If desired, these sensors can also output a data value indicative of measurement quality.

The SR50A-series sensors meet the stringent requirements of snow depth measurement that make them well suited for a variety of other applications. The SR50A and SR50AH have rugged aluminum chassis that withstand many environments, but the aluminum chassis is not suitable for marine (salty) environments. The SR50A-316SS has a stainless-steel chassis with a parylene-coated transducer head that allows the sensor to be used in marine or other corrosive environments. The SR50AH includes a heater that prevents ice from coating the transducer, but the heater increases the power consumption of the sensor; see Appendix F, *SR50AH Heater Operation (p. F-1)*, for more information. Throughout this document SR50A will refer to all of the models unless specified otherwise.

NOTE

Sonic ranging sensors with integrated temperature sensors are also available from Campbell Scientific; see the SR50AT, SR50AT-316SS, and SR50ATH manual for more information.

SDI-12, RS-232, and RS-485 output options are available for measuring the SR50A. The SR50A is factory configured as an SDI-12 sensor (address 0) because Campbell dataloggers typically use the SDI-12 format. To use the RS-232 or RS-485 format, three jumpers inside the SR50A need to be moved (Section 9.1, *Disassembly/Assembly Procedures (p. 15)*, and Appendix C, *Jumper Settings (p. C-1)*). Refer to Appendix D, *RS-232 and RS-485 Operation (p. D-1)*, for more information.

6. Specifications

Features:

- Wide operating temperature range
- Compatible with Campbell Scientific CRBasic dataloggers: CR200(X) series, CR300 series, CR6 series, CR800 series, CR1000, CR3000, and CR5000

Power Requirements: 9 to 18 Vdc

Quiescent Power**Consumption (no heater)**

SDI-12 Mode: < 1.0 mA
RS-232/RS-485 Modes: < 1.25 mA (\leq 9600 bps),
 < 2.0 mA ($>$ 9600 bps)

Active Power

Consumption (no heater): 250 mA typical

Measurement Time: Less than 1.0 s typical for RS-232 or RS-485 measurements.
 1.2 s typical for SDI-12 measurements.

Selectable Outputs: SDI-12 (version 1.3)
 RS-232 (1200 to 38400 bps)
 RS-485 (1200 to 38400 bps)

Measurement Range: 0.5 to 10 m (1.6 to 32.8 ft)

Accuracy:	± 1 cm (± 0.4 in) or 0.4% of distance to target, whichever is greater. Accuracy specification excludes errors in the temperature compensation. An external temperature compensation is required for the SR50A.
Resolution:	0.25 mm (0.01 in)
Required Beam Angle Clearance:	30°
Operating Temperature Range:	-45 to 50 °C
Maximum Cable Length:	SDI-12 60 m (196.9 ft) RS-232 (9600 bps or less) 30 m (98.4 ft) RS-485 300 m (984.3 ft) ¹
Cable Type:	4 conductor, 2-twisted pair, 22 awg, Santoprene jacket
Chassis Types:	Aluminum or 316L stainless steel
Sensor Length:	10.1 cm (4 in)
Sensor Diameter:	7.6 cm (3 in)
Sensor Weight (no cable)	
Aluminum Chassis:	0.4 kg (0.88 lb)
Stainless-Steel Chassis:	0.795 kg (1.75 lb)
Cable Weight (15 ft):	0.25 kg (0.55 lb)
IP Rating	
Electrical Housing:	IP67
Transducer:	IP64
Compliance:	This device complies with Part 15 of the USA Federal Communications Commission (FCC) Rules. Operation in the USA is subject to the following two conditions: <ol style="list-style-type: none">1. This device may not cause harmful interference.2. This device must accept any interference received, including interference that may cause undesired operation. View the EU Declaration of Conformity at <ul style="list-style-type: none">• www.campbellsci.com/sr50a• www.campbellsci.com/sr50a-316ss• www.campbellsci.com/sr50ah

¹Power supply must not drop below 11.0 V or heavier gage wire is required.

7. Installation

If you are programming your datalogger with *Short Cut*, skip Section 7.2, *SDI-12 Wiring* (p. 10), and Section 7.3, *SDI-12 Programming* (p. 10). *Short Cut* does this work for you. See Section 4, *QuickStart* (p. 2), for a *Short Cut* tutorial.

If not using SDI-12, refer to Appendix D, *RS-232 and RS-485 Operation* (p. D-1), for wiring and programming information.

7.1 Sensor Mounting

7.1.1 Beam Angle

When mounting the SR50A, the sensor's beam angle needs to be considered. Mount the SR50A perpendicular to the intended target surface. The SR50A has a beam angle of approximately 30 degrees. This means that objects outside this 30-degree beam will not be detected nor interfere with the intended target. Any unwanted target must be outside the 30-degree beam angle.

Determine the required clearance for the beam angle using the following formula and FIGURE 7-1.

Clearance Radius formula:

$$CONE_{radius} = 0.268(CONE_{height})$$

Where,

$CONE_{height}$ = the distance to base (Section 7.1.2.1, *Reference Point* (p. 8))

$CONE_{radius}$ = clearance radius in the same measurement units as the $CONE_{height}$

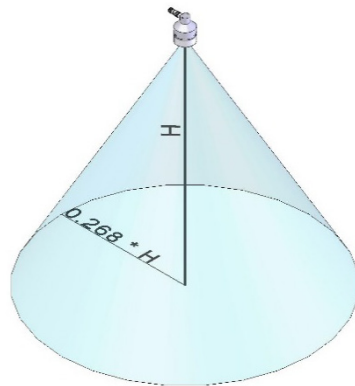

FIGURE 7-1. Beam Angle Clearance

7.1.2 Mounting Height

Mount the SR50A so that the face of the transducer is at least 50 cm (19.7 in) away from the target. However, mounting the sensor too far from the target can increase the absolute error. For example, if your sensor is measuring snow depth in an area that will likely not exceed 1.25 m (4.1 ft) then a good

height to mount the sensor will be 1.75 to 2.0 m (5.74 to 6.56 ft). Mounting the sensor at a 4 m (13.1 ft) height can result in larger snow depth errors.

7.1.2.1 Reference Point

The front grill on the ultrasonic transducer is used for the reference for the distance values. Because of the difficulty of measuring from the grill, most users measure the distance from the target to the outer edge of the plastic transducer housing (FIGURE 7-2), and then add 8 mm (0.3 in) to the measured distance.

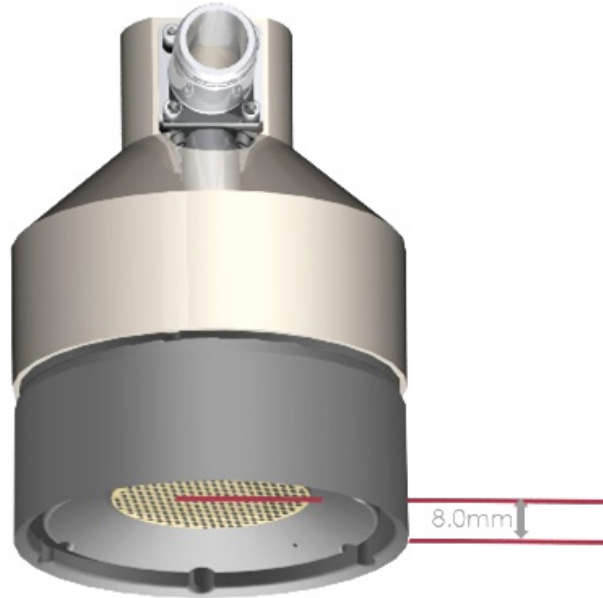

FIGURE 7-2. Distance from Edge of Transducer Housing to Grill

7.1.3 Mounting Options

To achieve an unobstructed view for the SR50A's beam, the SR50A is typically mounted to a tripod mast, tower leg, or user-supplied pole using the CM206 6-ft crossarm or a pipe with a 1-inch to 1.75-inch outer diameter. The 19517 mounting kit attaches directly to the crossarm or pipe. FIGURE 7-3 and FIGURE 7-4 show a couple of angles of the SR50A mounted to a crossarm using the 19517. A U-bolt mounts the bracket to the crossarm and two screws fasten the SR50A to the bracket.

The 19484 mounting stem (FIGURE 7-5) attaches to the crossarm using the 17953 Nu-Rail fitting (FIGURE 7-6), CM220 right-angle mount, CM230 adjustable-angle mount, or CM230XL extended adjustable-angle mount. Use the CM230 or CM230XL if the surface is at an angle.



FIGURE 7-3. SR50A Mounted to a Crossarm via the 19517 Mounting Kit



FIGURE 7-4. Another Angle of the 19517 Mounting Kit



FIGURE 7-5. SR50A Mounted to a 19484 Mounting Stem

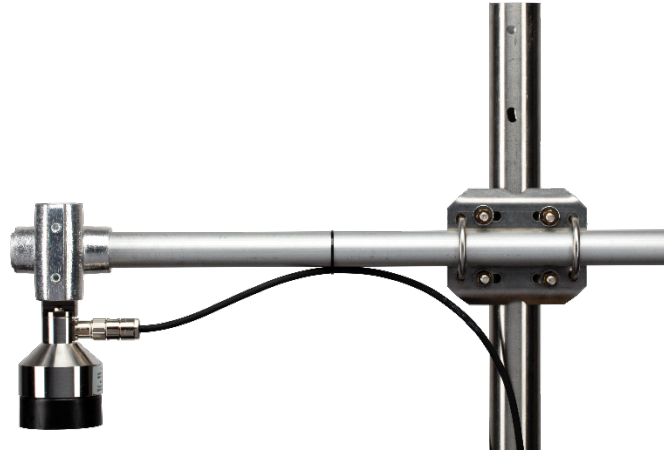

FIGURE 7-6. SR50A-316SS Mounted to a Crossarm with the 19484 and Nu-Rail Fitting

7.2 SDI-12 Wiring

CAUTION

Power down your system before wiring the SR50A. Never operate the sensor with the shield wire disconnected. The shield wire plays an important role in noise emissions and susceptibility as well as transient protection.

TABLE 7-1. Wire Color, Function, and Datalogger Connection

Wire Color	Wire Function	Datalogger Connection Terminal
Black	Power Ground	G
Red	Power	12V
Green	SDI-12 signal	Control Port¹ or U configured for SDI-12²
White	Ground	G
Clear	Shield	G

¹Dedicated **SDI-12** port on CR5000
²U channels are automatically configured by the measurement instruction.

To use more than one probe per datalogger, either connect the different sensors to different terminals on the datalogger or change the SDI-12 addresses of the sensors and wire them to the same terminal. Using the SDI-12 address reduces the use of ports on the datalogger and allows sensors to be connected in a daisy-chain that can minimize cable runs in some applications.

7.3 SDI-12 Programming

Short Cut is the best source for up-to-date datalogger programming code. Programming code is needed when:

- Creating a program for a new datalogger installation
- Adding sensors to an existing datalogger program

If your data acquisition requirements are simple, you can probably create and maintain a datalogger program exclusively with *Short Cut*. If your data acquisition needs are more complex, the files that *Short Cut* creates are a great source for programming code to start a new program or add to an existing custom program.

NOTE

Short Cut cannot edit programs after they are imported and edited in *CRBasic Editor*.

A *Short Cut* tutorial is available in Section 4, *QuickStart* (p. 2). If you wish to import *Short Cut* code into *CRBasic Editor* to create or add to a customized program, follow the procedure in Appendix A, *Importing Short Cut Code Into CRBasic Editor* (p. A-1). Programming basics for CRBasic dataloggers are in the following section. Complete program examples for select CRBasic dataloggers can be found in Appendix B, *Example Programs* (p. B-1). Programming basics and programming examples for Edlog dataloggers are provided at www.campbellsci.com/old-manuals.

7.3.1 SDI12Recorder() Instruction

The **SDI12Recorder()** measurement instruction programs CRBasic dataloggers (CR200(X) series, CR300 series, CR6 series, CR800-series, CR1000, CR3000, and CR5000) to measure the sensor. This instruction sends a request to the sensor to make a measurement and then retrieves the measurement from the sensor. See Section 8.3, *SDI-12 Measurements* (p. 13), for more information.

When using a CR200(X), the **SDI12Recorder()** instruction has the following syntax:

```
SDI12Recorder(Destination, OutString, Multiplier, Offset)
```

For the other CRBasic dataloggers, the **SDI12Recorder()** instruction has the following syntax:

```
SDI12Recorder(Destination, SDIPort, SDIAddress, "SDICommand",  
Multiplier, Offset)
```

8. Operation

The SR50A performs multiple echo processing regardless of output formats. It bases every measurement on several readings and applies an algorithm to improve measurement reliability.

The distance to target readings that are obtained from the sensor are referenced from the metal mesh on the face of the transducer. The SR50A projects an ultrasonic beam that can pick up objects in its field of view that is 30° or less. The closest object to the sensor will be detected if it is within this field of view. Unwanted objects must be outside the field of view. If a target is in motion, the SR50A may reject a reading if the target distance changes at a rate of 4 centimeters per second or more.

The SR50A completes a measurement and output the data typically in 1 second. In RS-232 and RS-485 serial modes, the data is completed within one second for baud rates of 9600 bps and above. The total time for an SDI-12

measurement can exceed 1 second due to the long communication times associated with the 1200 bps data rate.

If the SR50A rejects a reading or does not detect a target, zero will be output for distance to target or -999 for depth values.

8.1 Quality Numbers

Measurement quality numbers are available with the output data; these numbers indicate the measurement certainty (TABLE 8-1). Quality numbers have no units of measure and typically vary from 152 to 600. Numbers that are between 152 and 210 indicate good quality measurements. Zero indicates that the reading was not obtained. Numbers greater than 300 indicate a degree of uncertainty in the measurement. Causes of high numbers include:

- sensor is not perpendicular to the target surface
- target is small and reflects little sound
- target surface is rough or uneven
- target surface is a poor reflector of sound (extremely low density snow)

TABLE 8-1. Quality Number Description	
Quality Number Range	Quality Range Description
0	Not able to read distance
152 to 210	Good measurement quality numbers
210 to 300	Reduced echo signal strength
300 to 600	High measurement uncertainty

Although not necessary, quality numbers provide useful information such as surface density in snow monitoring applications. Please note that quality number values may increase during snowfall events consisting of low-density snow.

8.2 Temperature Compensation

The SR50A does not include a temperature sensor to compensate for the speed-of-sound variations in air temperature. Temperature corrections for the speed of sound will need to be applied to the readings. Use a reliable and accurate probe, such as the 107, to measure air temperature. A radiation shield is also required when the temperature probe will be exposed to solar radiation. Temperature compensation must be applied to the sensor output using the following formula:

$$DISTANCE = READING_{SR50A} \sqrt{\frac{T^{\circ}KELVIN}{273.15}}$$

CAUTION

The SR50A calculates a distance reading using the speed of sound at 0 °C (331.4 m/s). If the temperature compensation formula is not applied, the distance values will not be accurate for temperatures other than 0 °C.

8.3 SDI-12 Measurements

8.3.1 SDI-12 Addresses

The SR50A can be set to one of ten addresses (0 to 9) which allows up to ten sensors to be connected to a single digital I/O channel (control port) of an SDI-12 datalogger.

The SR50A is shipped from the factory with the address set to 0. The address on the SR50A can be changed by sending an SDI-12 change address command. The change address command can be issued from most SDI-12 recorders. For some Campbell Scientific dataloggers, the SDI-12 transparent mode will need to be entered to change the address.

When it is necessary to measure more than one SR50A, it is easiest to use a different control port for each SR50A instead of changing the address. If additional control ports are not available, then the address will need to be changed.

To change the address of a sensor that has the default address of 0 to the address of 1 the following command can be sent:

“0A1!”

Only one sensor of the same address should be connected when using the change address command.

8.3.2 SDI-12 Commands

The SDI-12 protocol supports the SDI-12 commands listed in TABLE 8-2.

NOTE

The SR50A needs to be powered for 1.5 s before it can receive an SDI-12 command.

The different commands are entered as options in the SDI-12 recorder instruction. The major difference between the various measurement commands are the data values that are returned. The user has the option to output the distance to target in either meters or feet, or to include the measurement quality numbers.

If the SR50A is unable to detect a proper echo for a measurement, the sensor will return a zero value for the distance to target value.

TABLE 8-2. SDI-12 Commands

SDI-12 Command	Command Function/Description	Values Returned
aM!	Distance-Meters	D
aM1!	Distance-Meters, Quality Number	D, Q
aM4!	Snow Depth Meters, Quality Number, Temperature	SD, Q, T
aM5!	Distance-Inches	D
aM6!	Distance-Inches, Quality Number	D, Q

SDI-12 Command	Command Function/Description	Values Returned
aMC! aMCn!	Measurement Commands with Checksum See aM and aM1- aM8	Output is the same as aM, aM1-aM9 Checksum is added
aC!	Concurrent Measurement Command Distance-Meters	D
aCn!	Concurrent Measurements Same as M1 through M8	Output is the Same as M1 through M8
aCC! aCCn!	Concurrent Measurement Commands with Checksum. See aM and aM1- aM8	Output is the same as aM, aM1-aM8 Checksum is added
aD0!	Send Data	Dependent upon command Sent
aV!	Verification command	S1,S2,V,WD S1 = Firmware Signature S2 = BootRom Signature WD = Watch Dog Errors
aI!	Send Identification	013CAMPBELLSR50A 2.0SN SN = <i>Serial number</i> (5 digits)
?!	Address Query	a
aAb!	Change Address command	b is the new address
aXM;D.DDD! Extended command	Set the distance to ground parameter in the SR50A. The distance must be in meters with no more than three decimal places.	A Address is returned
aXI;DDD.DD! Extended command	Set the distance to ground parameter in the SR50A. The distance must be in Inches with no more than two decimal places.	A Address is returned
aXT;CC.CC! Extended command	Provide the SR50A with a temperature value to perform on board temperature compensation. The temperature must be in degrees Celsius with a maximum of seven characters including sign and decimal.	A Address is returned
aR0!	Returns the distance to ground setting in the SR50A. The units returned are in meters	DG
aR1!	Returns the distance to ground setting in the SR50A. The units returned are in inches	DG
aR2!	Returns the temperature sent to the SR50A for internal temperature compensation. This value remains the same unless power is cycled or a new temperature values is sent.	T
Where a = address of SDI-12 device. Where n = numbers 1 to 9		

9. Maintenance and Troubleshooting

The SR50A's electrostatic transducer requires equal pressure on both sides. Vent holes in the transducer housing are used to equalize pressure. Desiccant (pn 4091) placed inside the transducer housing helps prevent condensing humidity. Regularly inspect the desiccant and, if required, replace it. Desiccant capable of absorbing moisture is blue. Once the desiccant becomes saturated, the color changes from blue to pink. In humid environments, replace the desiccant more frequently. Inspection or replacement of the desiccant requires the SR50A to be disassembled (Section 9.1, *Disassembly/Assembly Procedures* (p. 15)).

Replace the transducer assembly every three years if it is not in a humid environment. Replace the transducer housing assembly every year in humid environments.

- Standard SR50A housing and maintenance kit: pn 19486.
- SR50A open-faced housing and maintenance kit (used with the SR50A-316SS model): pn 32570.
- SR50AH housing and maintenance kit: pn 32571.

9.1 Disassembly/Assembly Procedures

FIGURES 9-1 through 9-6 show the procedure for disassembling the SR50A. Disassembly is required to inspect or replace the desiccant, and to change the transducer and the option jumpers.

CAUTION Before proceeding with any maintenance, always retrieve the data first. Campbell Scientific also recommends saving the datalogger program.

CAUTION Always disconnect the SR50A from the datalogger or the connector before disassembling.

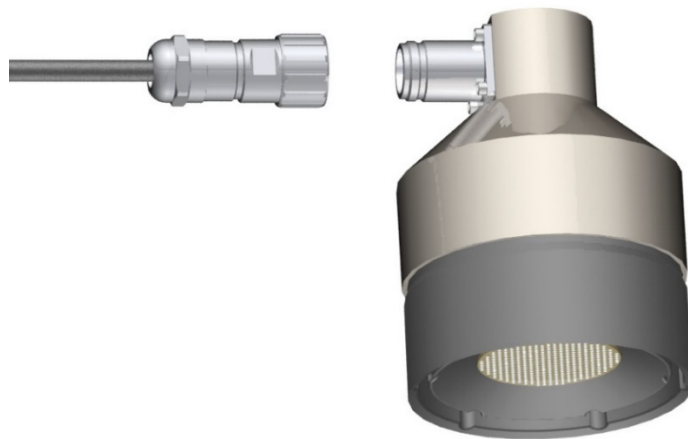

FIGURE 9-1. Disconnect Cable from Sensor



FIGURE 9-2. Remove Six Screws from the Transducer Housing

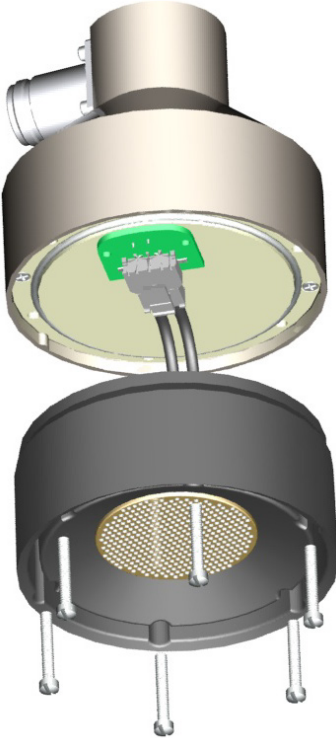

FIGURE 9-3. Remove Transducer Housing and Disconnect Wires



FIGURE 9-4. Location of Desiccant in Transducer Housing Assembly

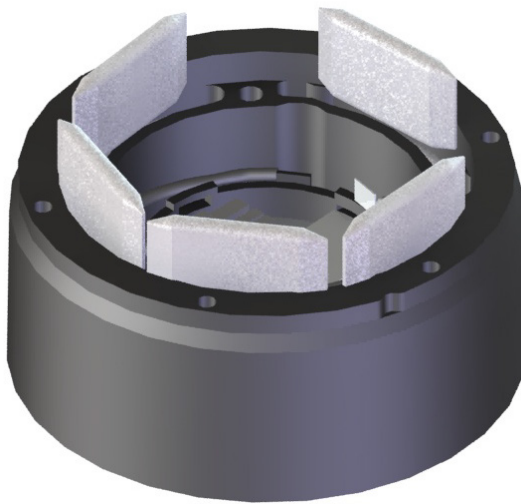

FIGURE 9-5. Remove and Replace Desiccant

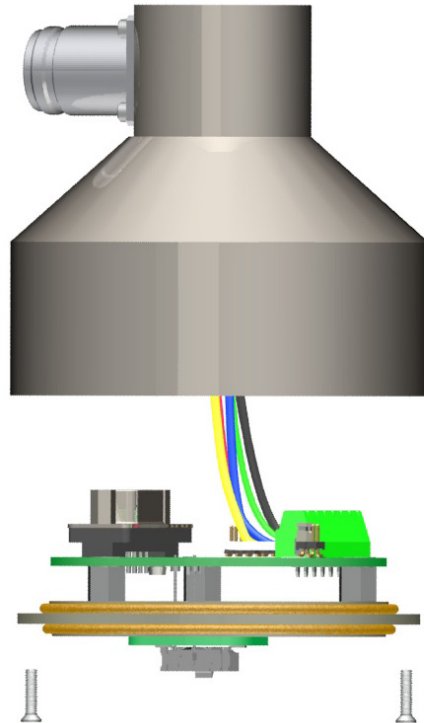

FIGURE 9-6. Remove the Two Flat Phillips Screws to Expose the PCB

Carefully reassemble in reverse order.

9.2 Data Interpretation and Filtering

9.2.1 Data Interpretation

Although not common, the SR50A can occasionally output invalid reading indicators if it was unable to obtain a measurement. For distance to target values, a 0.0 reading is usually output. For snow depth outputs, the error indicator value is -999. An invalid temperature reading is also indicated by a -999 reading. For snow depth applications, these can be easily filtered out when analyzing the data.

Consideration should be taken in a control type application to deal with invalid readings. For example, if the sensor is used to initiate a water level alarm, multiple readings should be used to ensure that a single invalid reading does not trigger the alarm condition.

9.2.2 Data Filtering

There are scenarios where the SR50A can produce values with higher than expected errors. For example, in very low density snow, very little echo is returned back to the sensor. The increase in echo quality numbers is an indication of the weak signals. Under these circumstances, an SR50A can under, or over, estimate snow depth. If the signal is too weak, the sensor will also output a value of 0 for the distance to target. When the echoes are weak, the sensor also automatically increases sensitivity. This makes the sensor more

prone to the occasional erroneous reading from flying debris, drifting snow, or mounting hardware just outside the beam angle.

The reason not to average values is that occasionally a number with a very high error value is produced, skewing the average. The value should be ignored and not averaged. Based on experience, the best technique to eliminate errors and filter out high error readings is to take the median value. This technique also helps to automatically filter out zero readings that can occasionally be produced.

For example, for a given station, a reading is taken every 5 seconds for 1 minute and the median value is taken from the readings. All the programming examples in this manual use this method for data filtering.

If 11 consecutive values are as follows for snow depth	After being sorted from low to high
0.33	-1.1
0.34	0.10
0.35	0.28
-1.1 (erroneous reading)	0.32
2.0 (erroneous reading)	0.33
0.37	0.33
0.28	0.34
0.36	0.35
0.10 (high error value)	0.36
0.33	0.37
0.32	2.0

The best course of action would be to ignore the 5 lowest values and take the 6th value (0.33).

Appendix A. Importing Short Cut Code Into CRBasic Editor

This tutorial shows the following:

- How to import a *Short Cut* program into a program editor for additional refinement
- How to import a wiring diagram from *Short Cut* into the comments of a custom program

Short Cut creates files, which can be imported into *CRBasic Editor*. Assuming defaults were used when *Short Cut* was installed, these files reside in the C:\campbellsci\SCWin folder:

- .DEF (wiring and memory usage information)
- .CR2 (CR200(X)-series datalogger code)
- .CR300 (CR300-series datalogger code)
- .CR6 (CR6-series datalogger code)
- .CR8 (CR800-series datalogger code)
- .CR1 (CR1000 datalogger code)
- .CR3 (CR3000 datalogger code)
- .CR5 (CR5000 datalogger code)

Use the following procedure to import *Short Cut* code and wiring diagram into *CRBasic Editor*:

1. Create the *Short Cut* program following the procedure in Section 4, *QuickStart* (p. 2). Finish the program and exit *Short Cut*. Make note of the file name used when saving the *Short Cut* program.
2. Open *CRBasic Editor*.
3. Click **File | Open**. Assuming the default paths were used when *Short Cut* was installed, navigate to C:\CampbellSci\SCWin folder. The file of interest has the .CR2, .CR300, .CR6, .CR8, .CR1, .CR3, or .CR5 extension. Select the file and click **Open**.
4. Immediately save the file in a folder different from C:\Campbellsci\SCWin, or save the file with a different file name.

NOTE

Once the file is edited with *CRBasic Editor*, *Short Cut* can no longer be used to edit the datalogger program. Change the name of the program file or move it, or *Short Cut* may overwrite it next time it is used.

5. The program can now be edited, saved, and sent to the datalogger.
6. Import wiring information to the program by opening the associated .DEF file. Copy and paste the section beginning with heading “-Wiring for CRXXX-” into the CRBasic program, usually at the head of the file. After pasting, edit the information such that an apostrophe (') begins each line. This character instructs the datalogger compiler to ignore the line when compiling.

Appendix B. Example Programs

B.1 SDI-12 Example Programs

TABLE B-1. Wiring for CR1000 and CR6 SDI-12 Example Programs			
107-L Air Temperature Sensor Wiring			
Wire Color	Sensor Wire Description	CR1000 Wire Channels	CR6 Wire Channels
Black	Voltage-excitation input	VX1	U2
Red	Analog-voltage output	SE1	U1
Purple	Bridge resistor lead	⊥	⊥
Shield	EMF shield	⊥	⊥
SR50A-L Configured for SDI-12 Wiring			
Wire Color	Sensor Wire Description	CR1000 Wire Channels	CR6 Wire Channels
Red	Power source	12V	12V
Green	SDI-12 I/O	C1	C1
White	Not used	G	G
Black	Ground	G	G
Shield	Shield/Earth ground	G	G

B.1.1 CR1000 SDI-12 Program

```

CRBasic Example B-1. CR1000 SDI-12 Program

'CR1000
'This program contains a number of features not found in Short Cut.
'
'The initial distance value from the SR50A head to the ground is
'measured by setting the flag SR50A_MID to TRUE. Set this flag after
'installing the SR50A in the field. Setting this flag will initiate
'a measurement cycle and the resulting value stored as the initial
'distance. The initial distance is used to calculate snow depth.
'The PreserveVariables instruction is used to store the initial
'distance in non-volatile memory. If power is lost at the site the
'initial distance value will be restored.'

'A control flag is used to initiate the SR50A measurement cycle. This
'allows for manual control in the field to check distances without
'waiting for the correct time interval to occur. It is also used by
'the datalogger to initiate an automated measurement cycle.
'
'Every measurement cycle is composed of 11 individual measurements
'that are spatially sorted to eliminate any low or high values.
'One measurement is made with each scan. This program has a 10
'second scan rate so it will take 100 seconds to do all 11 scans or
'1 minute and 40 seconds.

'Declare Variables and Units
Public BattV      : Units BattV      = Volts 'CR1000 battery voltage

```

```

Public PnlTmp_C : Units PnlTmp_C = °C      'CR1000 panel temperature
Public AirTempC : Units AirTempC = °C      'Air temperature

Public SR50A_Raw(2)
Alias SR50A_Raw(1) = DT : Units DT = meters 'Distance from the SR50A.
Alias SR50A_Raw(2) = RawQ : Units RawQ = unitless 'Quality number.

'Array to hold 11 SR50A measurements composed of a distance and
'quality number.
Public SR50A(11,2)

'Sorted array of 11 SR50A measurements composed of a distance and
'quality number. Measurements are sorted by the distance value from
'smallest to largest.
Public Result_SR50A(11,2)

Public TCDT : Units TCDT = meters          'Temperature corrected distance
Public Q : Units Q = unitless              'Quality number

Public Inital_Dist : Units Inital_Dist = meters 'Distance to ground.
Public Snow_Depth : Units Snow_Depth = meters 'Snow depth.

'Controls SR50A measurement. This flag can be manually controlled to
'run tests in the field or is automatically set 2 minutes before the
'hourly data storage interval. This is done so 11 measurements can
'be made and sorted before the values are stored.
Public SR50ACtrl As Boolean

'Set this flag to measure and store the initial distance from the
'SR50A to the ground.
Public SR50A_MID As Boolean

Dim n 'used as a counter

'Define Data Tables
DataTable(Daily,True,-1)
  DataInterval(0,1440,Min,10)
  Minimum(1,BattV,FP2,False,False)
  Maximum(1,BattV,FP2,False,False)
  Minimum(1,PnlTmp_C,FP2,False,False)
  Maximum(1,PnlTmp_C,FP2,False,False)
EndTable

DataTable(Hour,True,-1)
  DataInterval(0,60,Min,10)
  Sample(1,AirTempC,FP2)
  Sample(1,TCDT,IEEE4)
  Sample(1,Q,FP2)
EndTable

PreserveVariables

'Main Program
BeginProg
'Main Scan
n = 1
Scan(10,Sec,1,0)
  'Battery Voltage measurement 'BattV'
  Battery(BattV)

  'Wiring Panel Temperature measurement 'PnlTmp_C'
  PanelTemp(PnlTmp_C,_60Hz)

  '107 Temperature Probe measurement 'AirTempC'
  Therm107(AirTempC,1,1,1,0,_60Hz,1,0)

'Automated snow depth measurement. Must occur two minutes before
'actual storage time to get 11 measurements completed.

```

```

If TimeIntoInterval (58,60,Min) Then
  SR50ACtrl = True
EndIf

'Set this flag to true to get the initial distance from the SR50A
'to the ground.
If SR50A_MID Then SR50ACtrl = True

'Logic to make 11 snow depth measurements, sort them, and store
'the corrected values.
If SR50ACtrl Then
  'SR50A Sonic Ranging Sensor (SDI-12 Output) measurements
  'DT' & 'Q'
  SDI12Recorder(SR50A_Raw(),1,"0","M1!",1,0)
  'Calculate the temperature corrected distance.
  SR50A(n,1) = SR50A_Raw(1)*SQR((AirTempC+273.15)/273.15)
  SR50A(n,2) = SR50A_Raw(2)
  n += 1
  If n > 11 Then
    n = 1
    SR50ACtrl = False
    SortSpa (Result_SR50A(1,1),11,SR50A(1,1),2)
    TCDT = Result_SR50A(6,1)
    Q = Result_SR50A(6,2)
    If SR50A_MID Then
      Inital_Dist = TCDT
      SR50A_MID = False
    EndIf
    Snow_Depth = Inital_Dist - TCDT
  EndIf
EndIf

'Call Data Tables and Store Data
CallTable Daily
CallTable Hour
NextScan
EndProg

```

B.1.2 CR6 SDI-12 Program

CRBasic Example B-2. CR6 SDI-12 Program

```

'CR6
'This program contains a number of features not found in Short Cut.
'
'The initial distance value from the SR50A head to the ground is
'measured by setting the flag SR50A_MID to TRUE. Set this flag after
'installing the SR50A in the field. Setting this flag will initiate
'a measurement cycle and the resulting value stored as the initial
'distance. The initial distance is used to calculate snow depth.
'The PreserveVariables instruction is used to store the initial
'distance in non-volatile memory. If power is lost at the site the
'initial distance value will be restored.'
'
'A control flag is used to initiate the SR50A measurement cycle. This
'allows for manual control in the field to check distances without
'waiting for the correct time interval to occur. It is also used by
'the datalogger to initiate an automated measurement cycle.
'
'Every measurement cycle is composed of 11 individual measurements
'that are spatially sorted to eliminate any low or high values.
'One measurement is made with each scan. This program has a 10
'second scan rate so it will take 100 seconds to do all 11 scans or
'1 minute and 40 seconds.
'
'Declare Variables and Units

```

```

Public BattV      : Units BattV = Volts  'CR6 battery voltage
Public PnlTmp_C  : Units PnlTmp_C = °C   'CR6 panel temperature
Public AirTempC  : Units AirTempC = °C   'Air temperature

'Array to hold 11 SR50A measurements composed of a distance and
'quality number.
Public SR50A(11,2)

Public SR50A_Raw(2)
Alias SR50A_Raw(1) = DT : Units DT = meters 'Distance from the SR50A.
Alias SR50A_Raw(2) = RawQ : Units RawQ = unitless 'Quality number.

'Sorted array of 11 SR50A measurements composed of a distance and
'quality number. Measurements are sorted by the distance value from
'smallest to largest.
Public Result_SR50A(11,2)

Public TCDDT      : Units TCDDT = meters 'Temperature corrected distance
Public Q          : Units Q = unitless 'Quality number

Public Inital_Dist : Units Inital_Dist = meters 'Distance to ground.
Public Snow_Depth : Units Snow_Depth = meters 'Snow depth.

'Controls SR50A measurement. This flag can be manually controlled to
'run tests in the field or is automatically set 2 minutes before the
'hourly data storage interval. This is done so 11 measurements can
'be made and sorted before the values are stored.
Public SR50ACtrl As Boolean

'Set this flag to measure and store the initial distance from the
'SR50A to the ground.
Public SR50A_MID As Boolean

Dim n 'used as a counter

'Define Data Tables
DataTable(Daily,True,-1)
  DataInterval(0,1440,Min,10)
  Minimum(1,BattV,FP2,False,False)
  Maximum (1,BattV,FP2,False,False)
  Minimum(1,PnlTmp_C,FP2,False,False)
  Maximum (1,PnlTmp_C,FP2,False,False)
EndTable

DataTable (Hour,True,-1 )
  DataInterval (0,60,Min,10)
  Sample (1,AirTempC,FP2)
  Sample (1,TCDDT,IEEE4)
  Sample (1,Q,FP2)
EndTable

PreserveVariables

'Main Program
BeginProg
  'Main Scan
  n = 1
  Scan(10,Sec,1,0)
  'Battery Voltage measurement 'BattV'
  Battery(BattV)

  'Wiring Panel Temperature measurement 'PnlTmp_C'
  PanelTemp(PnlTmp_C,60)

  '107 Temperature Probe measurement 'AirTempC'
  Therm107(AirTempC,1,U1,U2,0,60,1,0)

  'Automated snow depth measurement. Must occur two minutes before

```

```

'actual storage time to get 11 measurements completed.
If TimeIntoInterval (13,15,Min) Then
  SR50ACtrl = True
EndIf

'Set this flag to true to get the initial distance from the SR50A
'to the ground.
If SR50A_MID Then SR50ACtrl = True

'Logic to make 11 snow depth measurements, sort them, and store
'the corrected values.
If SR50ACtrl Then
  'SR50A Sonic Ranging Sensor (SDI-12 Output) measurements
  'DT' & 'Q'
  SDI12Recorder(SR50A_Raw(),C1,"0","M1!",1,0)
  'Calculate the temperature corrected distance.
  SR50A(n,1) = SR50A_Raw(1)*SQR((AirTempC+273.15)/273.15)
  SR50A(n,2) = SR50A_Raw(2)
  n += 1
  If n > 11 Then
    n = 1
    SR50ACtrl = False
    SortSpa (Result_SR50A(1,1),11,SR50A(1,1),2)
    TCDT = Result_SR50A(6,1)
    Q = Result_SR50A(6,2)
    If SR50A_MID Then
      Inital_Dist = TCDT
      SR50A_MID = False
    EndIf
    Snow_Depth = Inital_Dist - TCDT
  EndIf
EndIf

'Call Data Tables and Store Data
CallTable Daily
CallTable Hour
NextScan
EndProg

```

B.2 RS-232 Example Programs

Detailed information using RS-232 and RS-485 is provided in Appendix D, *RS-232 and RS-485 Operation (p. D-1)*.

TABLE B-2. Wiring for CR1000 and CR6 RS-232 Example Programs

107-L Air Temperature Sensor Wiring			
Wire Color	Sensor Wire Description	CR1000 Wire Channels	CR6 Wire Channels
Black	Voltage-excitation input	VX1	U2
Red	Analog-voltage output	SE1	U1
Purple	Bridge resistor lead	⊥	⊥
Shield	EMF shield	⊥	⊥
SR50A-L Configured for RS-232 Wiring			
Wire Color	Sensor Wire Description	CR1000 Wire Channels	CR6 Wire Channels
Red	Power source	12V	12V
White	SR50A RX	C1	C1
Green	SR50A Tx	C2	C2
Black	Ground	G	G
Shield	Shield/Earth ground	⊥	⊥

B.2.1 CR1000 RS-232 Program

CRBasic Example B-3. CR1000 RS-232 Program

```
'CR1000 Series Datalogger
'This program contains a number of features not found in Short Cut.
'
'The initial distance value from the SR50A head to the ground is
'measured by setting the flag SR50A_MID to TRUE. Set this flag after
'installing the SR50A in the field. Setting this flag will initiate
'a measurement cycle and the resulting value stored as the initial
'distance. The initial distance is used to calculate snow depth.
'The PreserveVariables instruction is used to store the initial
'distance in non-volatile memory. If power is lost at the site the
'initial distance value will be restored.'

'A control flag is used to initiate the SR50A measurement cycle. This
'allows for manual control in the field to check distances without
'waiting for the correct time interval to occur. It is also used by
'the datalogger to initiate an automated measurement cycle.
'
'Every measurement cycle is composed of 11 individual measurements
'that are spatially sorted to eliminate any low or high values.
'One measurement is made with each scan. This program has a 10
'second scan rate so it will take 100 seconds to do all 11 scans or
'1 minute and 40 seconds.

'Declare Constants
'Default serial address of SR50A is 33. Polling command consists of
'a lower case 'p' followed by the address and a carriage return.
```

```

Const POLL_A = "p33" & CHR(13)

'Declare Variables and Units
Public BattV      : Units BattV      = Volts  'CR1000 battery voltage
Public Pn1Tmp_C  : Units Pn1Tmp_C  = 'C     'CR1000 panel temperature
Public AirTempC  : Units AirTempC  = 'C     'Air temperature

'Controls SR50A measurement. This flag can be manually controlled to
'run tests in the field or is automatically set 2 minutes before the
'hourly data storage interval. This is done so 11 measurements can
'be made and sorted before the values are stored.
Public SR50ACtrl As Boolean

'Set this flag to measure and store the initial distance from the
'SR50A to the ground.
Public SR50A_MID As Boolean

'Declare SR50AData as a dimensioned string of maximum 50 chrs
Public SR50AData As String * 50

'Values returned from the SR50A.
Public ParseVals(5) As Float
Alias ParseVals(1)=SerialAddress : Units SerialAddress = addr
Alias ParseVals(2)=Raw_Distance  : Units Raw_Distance  = meters
Alias ParseVals(3)=SignalQuality : Units SignalQuality = value
Alias ParseVals(4)=Diagnostics   : Units Diagnostics   = value
Alias ParseVals(5)=Chcksum       : Units Chcksum       = value

'Array to hold 11 SR50A measurements composed of a distance and
'quality number.
Public SR50A(11,2)

'Sorted array of 11 SR50A measurements composed of a distance and
'quality number. Measurements are sorted by the distance value from
'smallest to largest.
Public Result_SR50A(11,2)

Public TCDDT      : Units TCDDT      = meters  'Temperature corrected distance
Public Q          : Units Q          = unitless 'Quality number
Public Inital_Dist : Units Inital_Dist = meters  'Distance to ground.
Public Snow_Depth : Units Snow_Depth = meters  'Snow depth.

Dim n 'used as a counter

'SR50A diagnostic counters. Values are incremented if an error occurs.
Public ROM_Cntr      : Units ROM_Cntr      = value
Public SR50A_WtchDg_Cntr : Units SR50A_WtchDg_Cntr = value
Dim scratch

'Define Data Tables
DataTable(Daily,True,-1)
  DataInterval(0,1440,Min,10)
  Minimum(1,BattV,FP2,False,False)
  Maximum(1,BattV,FP2,False,False)
  Minimum(1,Pn1Tmp_C,FP2,False,False)
  Maximum(1,Pn1Tmp_C,FP2,False,False)
  Sample(1,ROM_Cntr,FP2)
  Sample(1,SR50A_WtchDg_Cntr,FP2)
EndTable

DataTable(Hour,True,-1)
  DataInterval(0,60,Min,10)
  Sample(1,AirTempC,FP2)
  Sample(1,TCDDT,IEEE4)
  Sample(1,Q,FP2)
EndTable

PreserveVariables

```

```

'Subroutine to sum up errors from the SR50A across the day.
Sub Diag
scratch = INT(Diagnostics/1000)
Select Case scratch
Case 0
SR50A_WtchDg_Cntr += 1
ROM_Cntr += 1
Case 1
SR50A_WtchDg_Cntr += 1
Case 10
ROM_Cntr += 1
EndSelect
EndSub

'Main Program
BeginProg
'Open and configure C1 and C2 for RS232 communication.
'9600 BAUD is the default:
SerialOpen (Com1,9600,0,0,200)
n = 1
Scan (10,Sec,3,0)
Battery (BattV)
PanelTemp (PnlTmp_C,_60Hz)
'Make an air temperature measurement.
Therm107 (AirTempC,1,1,Vx1,0,_60Hz,1.0,0)

'Automated snow depth measurement. Must occur two minutes before
'actual storage time to get 11 measurements completed.
If TimeIntoInterval (58,60,Min) Then
SR50ACtrl = True
EndIf

'Set this flag to true to get the initial distance from the SR50A
'to the ground.
If SR50A_MID Then SR50ACtrl = True

If SR50ACtrl Then
'Transmit serial command "p33<CR>"
SerialOut (Com1,POLL_A,"",0,0)
'Flush the serial buffer
SerialFlush (Com1)
'Recieve serial string from SR50A
SerialIn (SR50AData,Com1,200,CHR(13),50)
'Parse string into separate values.
SplitStr (ParseVals(),SR50AData,"",5,0)
'Calculate the temperature corrected distance.
SR50A(n,1) = ParseVals(2)*SQR((AirTempC+273.15)/273.15)
SR50A(n,2) = ParseVals(3)
n += 1
If n > 11 Then
n = 1
SR50ACtrl = False
SortSpa (Result_SR50A(1,1),11,SR50A(1,1),2)
TCDT = Result_SR50A(6,1)
Q = Result_SR50A(6,2)
If SR50A_MID Then
Initial_Dist = TCDT
SR50A_MID = False
EndIf
Snow_Depth = Initial_Dist - TCDT
EndIf
'Add up any errors across the day.
Call Diag
EndIf

'Call data tables.
CallTable Hour

```



```

CallTable Daily
'Clear diagnostic counters after Daily_Status table is stored.
If Daily.Output(1,1) Then
  ROM_Cntr = 0
  SR50A_WtchDg_Cntr = 0
EndIf
NextScan
EndProg

```

B.3 RS-485 Example Programs

Detailed information using RS-232 and RS-485 is provided in Appendix D, *RS-232 and RS-485 Operation (p. D-1)*.

B.3.1 CR1000 Programming Example Using an MD485 and SC110 9-pin Male Connector

For this example, an MD485 is used to convert the SR50A RS-485 signals to RS-232. A SC110 9-pin male connector cable is used to free up the RS-232 port on the datalogger.

MD485 is powered using a 14291 Field Power Cable.

TABLE B-3. 14291 Field Power Cable Connections

Field Power Cable Markings	CR1000 Datalogger or Directly to 12 Vdc Power Supply
Wire Marked (+)	12V
Wire Marked (-)	G

TABLE B-4. 107 and SC110 Wiring for CR1000 RS-232 Example Program

107-L Air Temperature Sensor Wiring		
Wire Color	Sensor Wire Description	CR1000 Wire Channels
Black	Voltage-excitation input	VX1
Red	Analog-voltage output	SE1
Purple	Bridge resistor lead	⊥
Shield	EMF shield	⊥
SC110 9-pin Male Connector Wiring (9-pin connector plugged into MD485 RS-232 port)		
Wire Color	SC110 Wire Description	CR1000 Wire Channels
Brown	RX	C1
White	TX	C2
Yellow	Ground	G
Shield	Shield/Earth ground	⊥

NOTE Wire tie back all unused SC110 wires so they don't short against any metal.

TABLE B-5. SR50A (Configured for MD485) Wiring to MD485 (9-pin connector plugged into MD485 RS-232 port)		
Wire Color	Wire Description	MD485 Wire Channel (except where indicated)
Red	Power source	CR1000 12V
Green	A	Any 'A' terminal
White	B	Any 'B' terminal
Black	Ground	⏏
Shield	Shield/Earth ground	CR1000 G

```

CRBasic Example B-4. CR1000 Programming Example Using an MD485 and SC110 9-pin Male Connector

'CR1000 Series Datalogger
'Program: SR50A_RS485_Port_C1-C2.CR1

'This program contains a number of features not found in Short Cut.
'
'The initial distance value from the SR50A head to the ground is
'measured by setting the flag SR50A_MID to TRUE. Set this flag after
'installing the SR50A in the field. Setting this flag will initiate
'a measurement cycle and the resulting value stored as the initial
'distance. The initial distance is used to calculate snow depth.
'The PreserveVariables instruction is used to store the initial
'distance in non-volatile memory. If power is lost at the site the
'initial distance value will be restored.'

'A control flag is used to initiate the SR50A measurement cycle. This
'allows for manual control in the field to check distances without
'waiting for the correct time interval to occur. It is also used by
'the datalogger to initiate an automated measurement cycle.
'
'Every measurement cycle is composed of 11 individual measurements
'that are spatially sorted to eliminate any low or high values.
'One measurement is made with each scan. This program has a 10
'second scan rate so it will take 100 seconds to do all 11 scans or
'1 minute and 40 seconds.
'Declare Constants

'Default serial address of SR50A is 33. Polling command consists of
'a lower case 'p' followed by the address and a carriage return.
Const POLL_A = "p33" & CHR(13)

'Declare Variables and Units
Public BattV : Units BattV = Volts 'CR1000 battery voltage
Public PnlTmp_C : Units PnlTmp_C = °C 'CR1000 panel temperature
Public AirTempC : Units AirTempC = °C 'Air temperature

'Controls SR50A measurement. This flag can be manually controlled to
'run tests in the field or is automatically set 2 minutes before the
'hourly data storage interval. This is done so 11 measurements can
'be made and sorted before the values are stored.
Public SR50ACtrl As Boolean
    
```

```

'Set this flag to measure and store the initial distance from the
'SR50A to the ground.
Public SR50A_MID As Boolean

'Declare SR50AData as a dimensioned string of maximum 50 chrs
Public SR50AData As String * 50

'Values returned from the SR50A.
Public ParseVals(5) As Float
Alias ParseVals(1)=SerialAddress : Units SerialAddress = addr
Alias ParseVals(2)=Raw_Distance : Units Raw_Distance = meters
Alias ParseVals(3)=SignalQuality : Units SignalQuality = value
Alias ParseVals(4)=Diagnostics : Units Diagnostics = value
Alias ParseVals(5)=Chcksum : Units Chcksum = value

'Array to hold 11 SR50A measurements composed of a distance and
'quality number.
Public SR50A(11,2)

'Sorted array of 11 SR50A measurements composed of a distance and
'quality number. Measurements are sorted by the distance value from
'smallest to largest.
Public Result_SR50A(11,2)

Public TCDT : Units TCDT = meters 'Temperature corrected distance
Public Q : Units Q = unitless 'Quality number
Public Inital_Dist : Units Inital_Dist = meters 'Distance to ground.
Public Snow_Depth : Units Snow_Depth = meters 'Snow depth.

Dim n 'used as a counter

'SR50A diagnostic counters. Values are incremented if an error occurs.
Public ROM_Cntr : Units ROM_Cntr = value
Public SR50A_WtchDg_Cntr : Units SR50A_WtchDg_Cntr = value
Dim scratch

'Define Data Tables
DataTable(Daily,True,-1)
DataInterval(0,1440,Min,10)
Minimum(1,BattV,FP2,False,False)
Maximum(1,BattV,FP2,False,False)
Minimum(1,Pn1Tmp_C,FP2,False,False)
Maximum(1,Pn1Tmp_C,FP2,False,False)
Sample(1,ROM_Cntr,FP2)
Sample(1,SR50A_WtchDg_Cntr,FP2)
EndTable

DataTable(Hour,True,-1)
DataInterval(0,60,Min,10)
Sample(1,AirTempC,FP2)
Sample(1,TCDT,IEEE4)
Sample(1,Q,FP2)
EndTable

PreserveVariables

'Subroutine to sum up errors from the SR50A across the day.
Sub Diag
scratch = INT(Diagnostics/1000)
Select Case scratch
Case 0
SR50A_WtchDg_Cntr += 1
ROM_Cntr += 1
Case 1
SR50A_WtchDg_Cntr += 1
Case 10
ROM_Cntr += 1

```

```

EndSelect
EndSub

'Main Program
BeginProg
'Open and configure RS232 port for RS232 communication.
'9600 BAUD is the default:
SerialOpen (Com1,9600,0,0,200)
n = 1
Scan (10,Sec,3,0)
  Battery (BattV)
  PanelTemp (PnlTmp_C,_60Hz)
  'Make an air temperature measurement.
  Therm107 (AirTempC,1,1,Vx1,0,_60Hz,1.0,0)

  'Automated snow depth measurement. Must occur two minutes before
  'actual storage time to get 11 measurements completed.
  If TimeIntoInterval (58,60,Min) Then
    SR50ACtrl = True
  EndIf

  'Set this flag to true to get the initial distance from the SR50A
  'to the ground.
  If SR50A_MID Then SR50ACtrl = True

  If SR50ACtrl Then
    'Transmit serial command "p33<CR>"
    SerialOut (Com1,POLL_A,"",0,0)
    'Flush the serial buffer
    SerialFlush (Com1)
    'Recieve serial string from SR50A
    SerialIn (SR50AData,Com1,200,CHR(13),50)
    'Pars string into separate values.
    SplitStr (ParseVals(),SR50AData,"",5,0)
    'Calculate the temperature corrected distance.
    SR50A(n,1) = ParseVals(2)*SQR((AirTempC+273.15)/273.15)
    SR50A(n,2) = ParseVals(3)
    n += 1
    If n > 11 Then
      n = 1
      SR50ACtrl = False
      SortSpa (Result_SR50A(1,1),11,SR50A(1,1),2)
      TCDT = Result_SR50A(6,1)
      Q = Result_SR50A(6,2)
      If SR50A_MID Then
        Inital_Dist = TCDT
        SR50A_MID = False
      EndIf
      Snow_Depth = Inital_Dist - TCDT
    EndIf
    'Add up any errors across the day.
    Call Diag
  EndIf

  'Call data tables.
  CallTable Hour
  CallTable Daily
  'Clear diagnostic counters after Daily_Status table is stored.
  If Daily.Output(1,1) Then
    ROM_Cntr = 0
    SR50A_WtchDg_Cntr = 0
  EndIf
NextScan
EndProg

```

B.3.2 CR6 RS-485 Programming Example

TABLE B-6. Wiring for CR6 RS-485 Program		
107-L Air Temperature Sensor Wiring		
Wire Color	Sensor Wire Description	CR6 Wire Channels
Black	Voltage-excitation input	U2
Red	Analog-voltage output	U1
Purple	Bridge resistor lead	⊥
Shield	EMF shield	⊥
SR50A-L Configured for RS-232 Wiring		
Wire Color	Sensor Wire Description	CR6 Wire Channels
Red	Power source	12V
Green	A	C1
White	B	C2
Black	Ground	G
Shield	Shield/Earth ground	⊥

CRBasic Example B-5. CR6 RS-485 Programming Example

```
'CR6 Series Datalogger
'This program contains a number of features not found in Short Cut.
'
'The initial distance value from the SR50A head to the ground is
'measured by setting the flag SR50A_MID to TRUE. Set this flag after
'installing the SR50A in the field. Setting this flag will initiate
'a measurement cycle and the resulting value stored as the initial
'distance. The initial distance is used to calculate snow depth.
'The PreserveVariables instruction is used to store the initial
'distance in non-volatile memory. If power is lost at the site the
'initial distance value will be restored.'

'A control flag is used to initiate the SR50A measurement cycle. This
'allows for manual control in the field to check distances without
'waiting for the correct time interval to occur. It is also used by
'the datalogger to initiate an automated measurement cycle.
'
'Every measurement cycle is composed of 11 individual measurements
'that are spatially sorted to eliminate any low or high values.
'One measurement is made with each scan. This program has a 10
'second scan rate so it will take 100 seconds to do all 11 scans or
'1 minute and 40 seconds.

'Declare Constants
'Default serial address of SR50A is 33. Polling command consists of
'a lower case 'p' followed by the address and a carriage return.
Const POLL_A = "p33" & CHR(13)

'Declare Variables and Units
Public BattV      : Units BattV      = Volts   'CR6 battery voltage
Public PnlTmp_C  : Units PnlTmp_C = °C       'CR6 panel temperature
Public AirTempC  : Units AirTempC = °C       'Air temperature
```

```

'Controls SR50A measurement. This flag can be manually controlled to
'run tests in the field or is automatically set 2 minutes before the
'hourly data storage interval. This is done so 11 measurements can
'be made and sorted before the values are stored.
Public SR50ACtrl As Boolean

'Set this flag to measure and store the initial distance from the
'SR50A to the ground.
Public SR50A_MID As Boolean

'Declare SR50AData as a dimensioned string of maximum 50 chrs
Public SR50AData As String * 50

'Values returned from the SR50A.
Public ParseVals(5) As Float
Alias ParseVals(1)=SerialAddress : Units SerialAddress = addr
Alias ParseVals(2)=Raw_Distance : Units Raw_Distance = meters
Alias ParseVals(3)=SignalQuality : Units SignalQuality = value
Alias ParseVals(4)=Diagnostics : Units Diagnostics = value
Alias ParseVals(5)=Chcksum : Units Chcksum = value

'Array to hold 11 SR50A measurements composed of a distance and
'quality number.
Public SR50A(11,2)

'Sorted array of 11 SR50A measurements composed of a distance and
'quality number. Measurements are sorted by the distance value from
'smallest to largest.
Public Result_SR50A(11,2)

Public TCDDT : Units TCDDT = meters 'Temperature corrected distance
Public Q : Units Q = unitless 'Quality number
Public Inital_Dist : Units Inital_Dist = meters 'Distance to ground.
Public Snow_Depth : Units Snow_Depth = meters 'Snow depth.

Dim n 'used as a counter

'SR50A diagnostic counters. Values are incremented if an error occurs.
Public ROM_Cntr : Units ROM_Cntr = value
Public SR50A_WtchDg_Cntr : Units SR50A_WtchDg_Cntr = value
Dim scratch

'Define Data Tables
DataTable(Daily,True,-1)
DataInterval(0,1440,Min,10)
Minimum(1,BattV,FP2,False,False)
Maximum(1,BattV,FP2,False,False)
Minimum(1,Pn1Tmp_C,FP2,False,False)
Maximum(1,Pn1Tmp_C,FP2,False,False)
Sample(1,ROM_Cntr,FP2)
Sample(1,SR50A_WtchDg_Cntr,FP2)
EndTable

DataTable(Hour,True,-1)
DataInterval(0,60,Min,10)
Sample(1,AirTempC,FP2)
Sample(1,TCDDT,IEEE4)
Sample(1,Q,FP2)
EndTable

PreserveVariables

'Subroutine to sum up errors from the SR50A across the day.
Sub Diag
scratch = INT(Diagnostics/1000)
Select Case scratch
Case 0

```

```

SR50A_WtchDg_Cntr += 1
ROM_Cntr += 1
Case 1
  SR50A_WtchDg_Cntr += 1
Case 10
  ROM_Cntr += 1
EndSelect
EndSub

'Main Program
BeginProg
  'Open and configure C1 and C2 for RS485 communication.
  '9600 BAUD is the default set at half-duplex:
  SerialOpen (ComC1,9600,0,0,200,4)
  n = 1

  Scan (10,Sec,0,0)
  Battery (BattV)
  PanelTemp (PnlTmp_C,60)
  'Make an air temperature measurement.
  Therm107 (AirTempC,1,U1,U2,0,60,1.0,0)

  'Automated snow depth measurement. Must occur two minutes before
  'actual storage time to get 11 measurements completed.
  If TimeIntoInterval (58,60,Min) Then
    SR50ACtrl = True
  EndIf

  'Set this flag to true to get the initial distance from the SR50A
  'to the ground.
  If SR50A_MID Then SR50ACtrl = True

  If SR50ACtrl Then
    'Transmit serial command "p33<CR>"
    SerialOut (ComC1,POLL_A,"",0,0)
    'Flush the serial buffer
    SerialFlush (ComC1)
    'Recieve serial string from SR50A
    SerialIn (SR50AData,ComC1,200,CHR(13),50)
    'Pars string into separate values.
    SplitStr (ParseVals(),SR50AData,"",5,0)
    'Calculate the temperature corrected distance.
    SR50A(n,1) = ParseVals(2)*SQR((AirTempC+273.15)/273.15)
    SR50A(n,2) = ParseVals(3)
    n += 1
    If n > 11 Then
      n = 1
      SR50ACtrl = False
      SortSpa (Result_SR50A(1,1),11,SR50A(1,1),2)
      TCDT = Result_SR50A(6,1)
      Q = Result_SR50A(6,2)
      If SR50A_MID Then
        Inital_Dist = TCDT
        SR50A_MID = False
      EndIf
      Snow_Depth = Inital_Dist - TCDT
    EndIf
    'Add up any errors across the day.
    Call Diag
  EndIf

  'Call data tables.
  CallTable Hour
  CallTable Daily
  'Clear diagnostic counters after Daily_Status table is stored.
  If Daily.Output(1,1) Then
    ROM_Cntr = 0
    SR50A_WtchDg_Cntr = 0
  EndIf

```

```

EndIf
NextScan
EndProg
    
```

B.4 Heater Program Examples

The following programs are written for a SR50AH-L configured for SDI-12. Detailed information about the heater is provided in Appendix F, *SR50AH Heater Operation* (p. F-1).

TABLE B-7. Wiring for CR1000 and CR6 Heater Example Programs

107-L Air Temperature Sensor Wiring			
Wire Color	Sensor Wire Description	CR1000 Wire Channels	CR6 Wire Channels
Black	Voltage-excitation input	VX1	U2
Red	Analog-voltage output	SE1	U1
Purple	Bridge resistor lead	⊥	⊥
Shield	EMF shield	⊥	⊥
SR50A-L Configured for SDI-12 Wiring			
Wire Color	Sensor Wire Description	CR1000 Wire Channels	CR6 Wire Channels
Red	Power source	12V	12V
Green	SDI-12 I/O	C1	C1
White	Not used	G	G
Black	Ground	G	G
Shield	Shield/Earth ground	G	G
SR50AH Heater Power Cable			
Wire Color	Heater Wire Description	CR1000 Wire Channels	CR6 Wire Channels
Black	Power source	SW-12	SW12-1
White	Power ground	G	G
Shield	Shield/Earth ground	⊥	⊥

CRBasic Example B-6. CR1000 Heater Program Example

```

'CR1000
'This program contains a number of features not found in Short Cut.
'
'The initial distance value from the SR50A head to the ground is
'measured by setting the flag SR50A_MID to TRUE. Set this flag after
'installing the SR50A in the field. Setting this flag will initiate
'a measurement cycle and the resulting value stored as the initial
'distance. The initial distance is used to calculate snow depth.
'The PreserveVariables instruction is used to store the initial
'distance in non-volatile memory. If power is lost at the site the
'initial distance value will be restored.'

'A control flag is used to initiate the SR50A measurement cycle. This
    
```



```

'allows for manual control in the field to check distances without
'waiting for the correct time interval to occur. It is also used by
'the datalogger to initiate an automated measurement cycle.
'
'Every measurement cycle is composed of 11 individual measurements
'that are spatially sorted to eliminate any low or high values.
'One measurement is made with each scan. This program has a 10
'second scan rate so it will take 100 seconds to do all 11 scans or
'1 minute and 40 seconds.

'Declare Variables and Units
Public BattV : Units BattV = Volts 'CR1000 battery voltage
Public PnlTmp_C : Units PnlTmp_C = °C 'CR1000 panel temperature
Public AirTempC : Units AirTempC = °C 'Air temperature
Public HtrCntrl As Boolean

Public SR50A_Raw(2)
Alias SR50A_Raw(1) = DT : Units DT = meters 'Distance from the SR50A.
Alias SR50A_Raw(2) = RawQ : Units RawQ = unitless 'Quality number.

'Array to hold 11 SR50A measurements composed of a distance and
'quality number.
Public SR50A(11,2)

'Sorted array of 11 SR50A measurements composed of a distance and
'quality number. Measurements are sorted by the distance value from
'smallest to largest.
Public Result_SR50A(11,2)

Public TCDT : Units TCDT = meters 'Temperature corrected distance
Public Q : Units Q = unitless 'Quality number

Public Inital_Dist : Units Inital_Dist = meters 'Distance to ground.
Public Snow_Depth : Units Snow_Depth = meters 'Snow depth.

'Controls SR50A measurement. This flag can be manually controlled to
'run tests in the field or is automatically set 2 minutes before the
'hourly data storage interval. This is done so 11 measurements can
'be made and sorted before the values are stored.
Public SR50ACtrl As Boolean

'Set this flag to measure and store the initial distance from the
'SR50A to the ground.
Public SR50A_MID As Boolean

Dim n 'used as a counter

'Define Data Tables
DataTable(Daily,True,-1)
DataInterval(0,1440,Min,10)
Minimum(1,BattV,FP2,False,False)
Maximum(1,BattV,FP2,False,False)
Minimum(1,PnlTmp_C,FP2,False,False)
Maximum(1,PnlTmp_C,FP2,False,False)
EndTable

DataTable(Hour,True,-1)
DataInterval(0,60,Min,10)
Sample(1,AirTempC,FP2)
Sample(1,TCDT,IEEE4)
Sample(1,Q,FP2)
EndTable

PreserveVariables

'Main Program
BeginProg
'Main Scan

```

```

n = 1
Scan(10,Sec,1,0)
  'Battery Voltage measurement 'BattV'
  Battery(BattV)

  'Wiring Panel Temperature measurement 'PnlTmp_C'
  PanelTemp(PnlTmp_C,_60Hz)

  '107 Temperature Probe measurement 'AirTempC'
  Therm107(AirTempC,1,1,1,0,_60Hz,1,0)

  'Automated snow depth measurement. Must occur two minutes before
  'actual storage time to get 11 measurements completed.
  If TimeIntoInterval (58,60,Min) Then
    SR50ACtrl = True
  EndIf

  'Set this flag to true to get the initial distance from the SR50A
  'to the ground.
  If SR50A_MID Then SR50ACtrl = True

  'Logic to make 11 snow depth measurements, sort them, and store
  'the corrected values.
  If SR50ACtrl Then
    'SR50A Sonic Ranging Sensor (SDI-12 Output) measurements
    'DT' & 'Q'
    SDI12Recorder(SR50A_Raw(),1,"0","M1!",1,0)
    'Calculate the temperature corrected distance.
    SR50A(n,1) = SR50A_Raw(1)*SQR((AirTempC+273.15)/273.15)
    SR50A(n,2) = SR50A_Raw(2)
    n += 1
    If n > 11 Then
      n = 1
      SR50ACtrl = False
      SortSpa (Result_SR50A(1,1),11,SR50A(1,1),2)
      TCDT = Result_SR50A(6,1)
      Q = Result_SR50A(6,2)
      If SR50A_MID Then
        Inital_Dist = TCDT
        SR50A_MID = False
      EndIf
      Snow_Depth = Inital_Dist - TCDT
    EndIf
  EndIf
  'SR50A Heater Control
  If BattV >= 11.7 Then
    If AirTempC <= 2 Then HtrCntrl = True
    If AirTempC > 3 Then HtrCntrl = False
  Else
    HtrCntrl = False
  EndIf
  SW12(HtrCntrl)
  'Call Data Tables and Store Data
  CallTable Daily
  CallTable Hour
NextScan
EndProg

```

CRBasic Example B-7. CR6 Heater Program Example

```

'CR6
'This program contains a number of features not found in Short Cut.
'
'The initial distance value from the SR50A head to the ground is
'measured by setting the flag SR50A_MID to TRUE. Set this flag after
'installing the SR50A in the field. Setting this flag will initiate
'a measurement cycle and the resulting value stored as the initial
'distance. The initial distance is used to calculate snow depth.
'The PreserveVariables instruction is used to store the initial
'distance in non-volatile memory. If power is lost at the site the
'initial distance value will be restored.'

'A control flag is used to initiate the SR50A measurement cycle. This
'allows for manual control in the field to check distances without
'waiting for the correct time interval to occur. It is also used by
'the datalogger to initiate an automated measurement cycle.
'
'Every measurement cycle is composed of 11 individual measurements
'that are spatially sorted to eliminate any low or high values.
'One measurement is made with each scan. This program has a 10
'second scan rate so it will take 100 seconds to do all 11 scans or
'1 minute and 40 seconds.

'Declare Variables and Units
Public BattV : Units BattV = Volts 'CR6 battery voltage
Public PnlTmp_C : Units PnlTmp_C = °C 'CR6 panel temperature
Public AirTempC : Units AirTempC = °C 'Air temperature
Public HtrCntrl As Boolean

'Array to hold 11 SR50A measurements composed of a distance and
'quality number.
Public SR50A(11,2)

Public SR50A_Raw(2)
Alias SR50A_Raw(1) = DT : Units DT = meters 'Distance from the SR50A.
Alias SR50A_Raw(2) = RawQ : Units RawQ = unitless 'Quality number.

'Sorted array of 11 SR50A measurements composed of a distance and
'quality number. Measurements are sorted by the distance value from
'smallest to largest.
Public Result_SR50A(11,2)

Public TCDT : Units TCDT = meters 'Temperature corrected distance
Public Q : Units Q = unitless 'Quality number

Public Inital_Dist : Units Inital_Dist = meters 'Distance to ground.
Public Snow_Depth : Units Snow_Depth = meters 'Snow depth.

'Controls SR50A measurement. This flag can be manually controlled to
'run tests in the field or is automatically set 2 minutes before the
'hourly data storage interval. This is done so 11 measurements can
'be made and sorted before the values are stored.
Public SR50ACntrl As Boolean

'Set this flag to measure and store the initial distance from the
'SR50A to the ground.
Public SR50A_MID As Boolean

Dim n 'used as a counter

'Define Data Tables
DataTable(Daily,True,-1)
DataInterval(0,1440,Min,10)
Minimum(1,BattV,FP2,False,False)
Maximum(1,BattV,FP2,False,False)
Minimum(1,PnlTmp_C,FP2,False,False)

```

```

Maximum (1,Pn1Tmp_C,FP2,False,False)
EndTable

DataTable (Hour,True,-1 )
  DataInterval (0,60,Min,10)
  Sample (1,AirTempC,FP2)
  Sample (1,TCDT,IEEE4)
  Sample (1,Q,FP2)
EndTable

PreserveVariables

'Main Program
BeginProg
  'Main Scan
  n = 1
  Scan(10,Sec,1,0)
  'Battery Voltage measurement 'BattV'
  Battery(BattV)

  'Wiring Panel Temperature measurement 'Pn1Tmp_C'
  PanelTemp(Pn1Tmp_C,60)

  '107 Temperature Probe measurement 'AirTempC'
  Therm107(AirTempC,1,U1,U2,0,60,1,0)

  'Automated snow depth measurement. Must occur two minutes before
  'actual storage time to get 11 measurements completed.
  If TimeIntoInterval (13,15,Min) Then
    SR50ACtrl = True
  EndIf

  'Set this flag to true to get the initial distance from the SR50A
  'to the ground.
  If SR50A_MID Then SR50ACtrl = True

  'Logic to make 11 snow depth measurements, sort them, and store
  'the corrected values.
  If SR50ACtrl Then
    'SR50A Sonic Ranging Sensor (SDI-12 Output) measurements
    'DT' & 'Q'
    SDI12Recorder(SR50A_Raw(),C1,"0","M1!",1,0)
    'Calculate the temperature corrected distance.
    SR50A(n,1) = SR50A_Raw(1)*SQR((AirTempC+273.15)/273.15)
    SR50A(n,2) = SR50A_Raw(2)
    n += 1
    If n > 11 Then
      n = 1
      SR50ACtrl = False
      SortSpa (Result_SR50A(1,1),11,SR50A(1,1),2)
      TCDT = Result_SR50A(6,1)
      Q = Result_SR50A(6,2)
      If SR50A_MID Then
        Initial_Dist = TCDT
        SR50A_MID = False
      EndIf
      Snow_Depth = Initial_Dist - TCDT
    EndIf
  EndIf

  'SR50A Heater Control
  If BattV >= 11.7 Then
    If AirTempC <= 2 Then HtrCntrl = True
    If AirTempC > 3 Then HtrCntrl = False
  Else
    HtrCntrl = False
  EndIf
  SW12(1,HtrCntrl,1)
  'Call Data Tables and Store Data

```

```
CallTable Daily  
CallTable Hour  
NextScan  
EndProg
```

Appendix C. Jumper Settings

FIGURE C-1 shows the jumper locations of the SR50A.

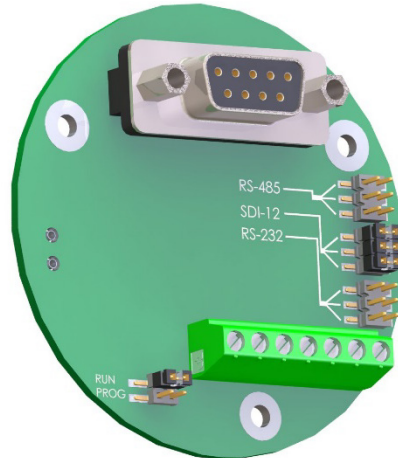

FIGURE C-1. Jumper Settings

The SR50A can be configured with either SDI-12, RS-232 or RS-485 communications. Shunt jumpers can be located on any of the three sets of communication selection headers. Only place the three jumpers on one group at a time. Never install more than three jumpers and never mix the jumpers among the SDI-12, RS-232 or RS-485 locations.

The other jumper located on the SR50A places the sensor in either the normal operation mode or in the program update mode. The program mode is only used for updating the internal firmware of the sensor. During operation, have the jumper in the **RUN** position.

Refer to Appendix E.2, *Sending New Firmware to a SR50A/T Sensor* for details about SR50A firmware updates.

Appendix D. RS-232 and RS-485 Operation

D.1 RS-232 Operation

The SR50A sensor comes from the factory with the internal jumpers set to SDI-12 mode. To use the SR50A in the RS-232 mode of operation, the jumpers need to be set as outlined in Appendix C, *Jumper Settings* (p. C-1). Complete RS-232 CRBasic programs can be found in Appendix B.2, *RS-232 Example Programs* (p. B-6).

D.1.1 RS-232 Wiring

FIGURE D-1 and TABLE D-1 show wiring for the SR50A in RS-232 mode. The ground used with the RS-232 connector (pin 5) must use the same ground as the SR50A. For the example below, the power for the SR50A is coming from the datalogger. A jumper wire is used from the RS-232 connector's pin 5 to the datalogger ground.

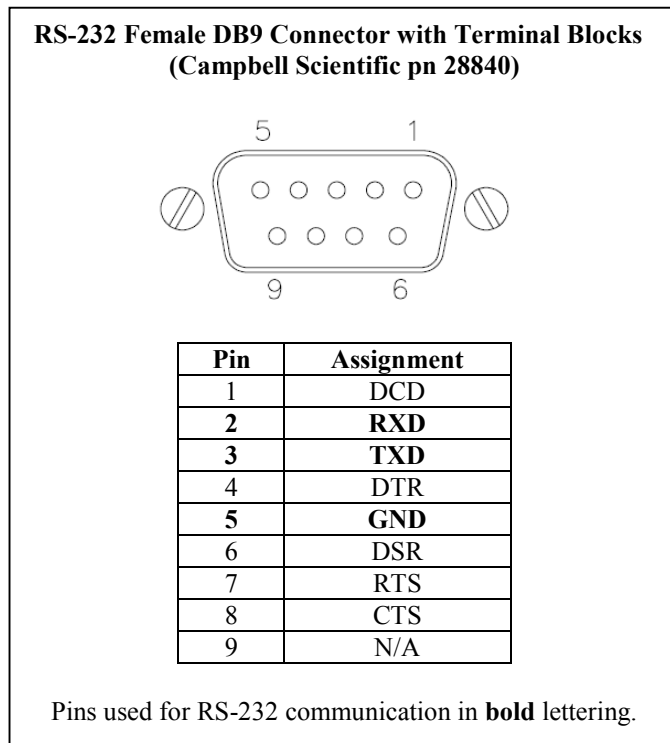

FIGURE D-1. RS-232 DB9 Connector Description

TABLE D-1. SR50A RS-232 Interface Wiring		
SR50A Wire Color	Function	Wiring Location
Red	+12 Vdc Power	Power Source (Datalogger: 12V)
Black	Power Ground	System Ground and/or RS-232 Receiver Ground (Datalogger: G)
Green	RS-232 (SR50A Output)	Pin 2 [RXD] (9-pin RS-232 Interface Connector: pn 28840)
White	RS-232 (SR50A Input)	Pin 3 [TXD] (9-pin RS-232 Interface Connector: pn 28840)
Clear	Shield	G (datalogger)
Jumper Wire		Pin 5 [G] (9-pin RS-232 Interface Connector: pn 28840)

TABLE D-2. SR50A Datalogger COM Port Wiring			
SR50A Wire Color	Function	CR1000	CR6
Red	+12 Vdc Power	12V	12V
Black	Power Ground	G	G
Green	RS-232 (SR50A Output)	RX (COM1–COM4)	RX (COM1–COM2)
White	RS-232 (SR50A Input)	TX (COM1–COM4)	TX (COM1–COM2)
Clear	Shield	G	G

D.2 RS-485 Operation

The SR50A sensor comes from the factory with the internal jumpers set to SDI-12 mode. To use the SR50A in the RS-485 mode of operation, the jumpers need to be set as outlined in Appendix C, *Jumper Settings (p. C-1)*. Complete RS-485 CRBasic programs can be found in Appendix B.3, *RS-485 Example Programs (p. B-9)*.

The RS-485 on the SR50A supports half-duplex communications, which means the SR50A can receive and transmit data, but not simultaneously. Normally a master-slave relationship is used in most systems to avoid collisions between transmissions. For this reason, the *Auto Measure Output* is not recommended for RS-485 communications. It is much better to have a master initiate the communications by using the *Measure On Poll* or the *Auto Measure Polled Output* modes.

You can use Campbell Scientific's MD485 interface to connect one or more SR50A sensors in RS-485 mode to an RS-232 device. This can be useful for

sensors that require lead lengths that exceed the limits of either RS-232 or SDI-12 communications.

The SR50A can be connected directly the RS-485 port on the CR6 datalogger.

D.2.1 RS-485 Wiring Using a MD485

TABLE D-3 and FIGURE D-2 show the wiring for the SR50A in RS-485 mode.

TABLE D-3. Connections for RS-485 Mode		
Color	Function	Connection
Black	Power Ground	System Ground and/or RS-232 Receiver Ground (Pin 5 of a computer (DTE) DB-9 connector)
Red	Power	Power Source +12V
Green	RS-485 A	MD485 RS-485 A Terminal
White	RS-485 B	MD485 RS-485 B Terminal
Clear	Shield	Shield/Earth Ground

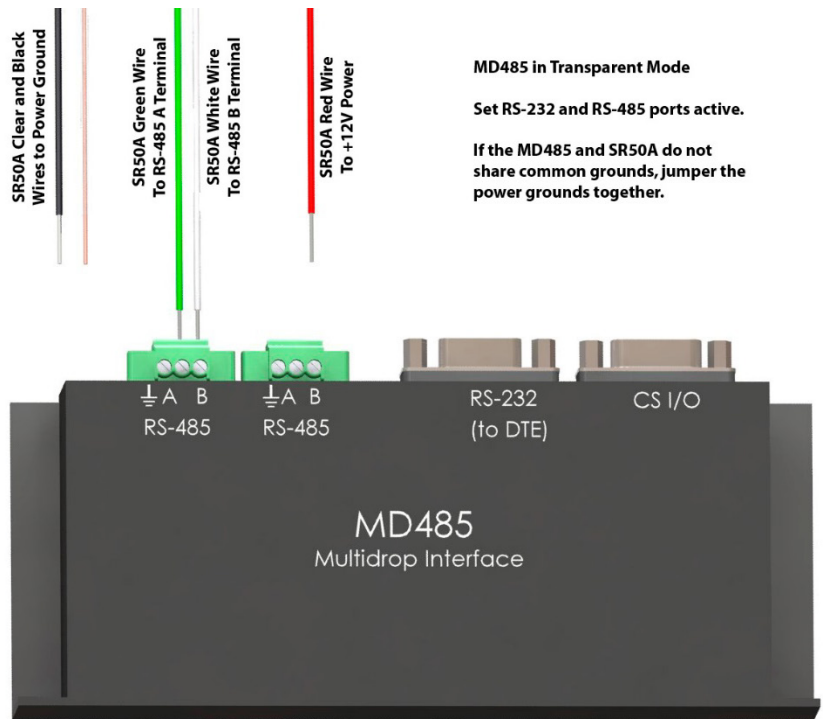

FIGURE D-2. SR50A to MD485 Wiring

D.3 RS-485 Wiring to a CR6 Datalogger

The SR50A is a half-duplex device and can only be used on the COM1 (C1 and C2) terminal blocks.

Color	Function	Connection
Black	Power Ground	G
Red	Power	12V
Green	RS-485 A	C1
White	RS-485 B	C2
Clear	Shield	G

D.4 RS-232 and RS-485 Settings

Once the jumpers are set for RS-232 operation, a terminal program such as *Device Configuration Utility* or *Tera Term* can be used to change factory defaults or existing settings. Use a terminal program that allows local echo. The SR50A does not echo key presses. To see what is being typed, **Local Echo** must be switched on. A quick introduction to *Tera Term* is located in Appendix E, *Tera Term QuickStart* (p. E-1). The following settings apply to *Device Configuration Utility* or any program used for communications.

Baud Rate: Current SR50A Setting^{Note}
Data Bits: 8
Parity: None
Stop Bits: 1
Flow Control: None
Local Echo: On

NOTE

The factory default baud rate is 9600 bps. Once the baud rate is changed, the new baud rate must be used for further communications to the SR50A. Ensure to keep track of the baud rate setting on the SR50A. If the baud rate setting is unknown, try using the default value of 9600 bps. If that does not work, start the baud rate at 1200 bps and go through all the baud rate settings until the correct one is found.

Select the following when using *Device Configuration Utility* (FIGURE D-3).

- Device Type: **Unknown**
- Choose the correct COM port.
- By default, the baud rate in the SR50A and *Device Configuration Utility* is set to 9,600. Only change the baud rate if you know it has been changed in the SR50A.
- Click on the **Connect** button in the lower left hand corner.

- Uncheck the **All Caps** box.
- Check the **Echo Input** box.

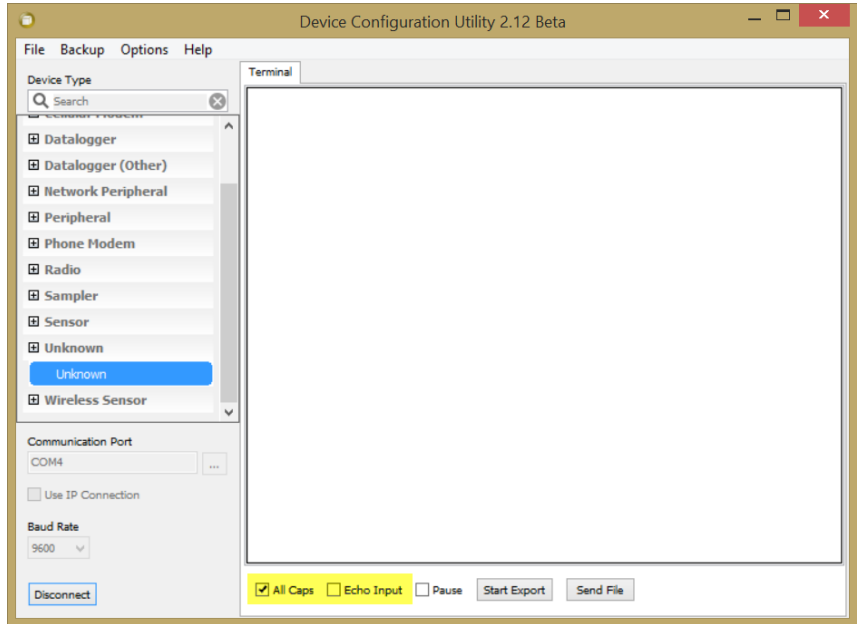

FIGURE D-3. Initial Terminal Window in Device Configuration Utility

To enter **Setup** mode, type “setup” in the terminal window and press the **Enter** key. The word “setup” and all options in the setup menu are not case sensitive.

The SR50A should respond with the setup menu shown in FIGURE D-4.

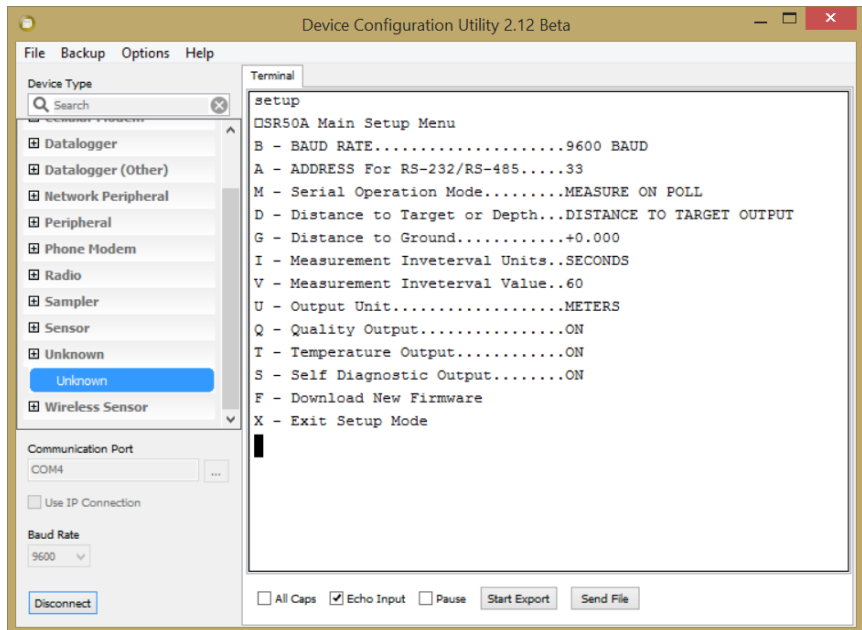

FIGURE D-4. SR50A Setup Menu

TABLE D-5 summarizes the settings that can be changed using the SR50A RS-232 or RS-485 operating modes. Recommended changes are shown in parenthesis.

TABLE D-5. RS-232 and RS-485 Settings		
Setting Description	Options	Default Value
Baud Rate	1200 4800 9600 19200 38400	9600 bps
Address RS-232/RS-485	Any two Alphanumeric Characters	33
Serial Operational Mode	Measure on Poll Auto Measure Auto Output Auto Measure Polled Output	Auto Measure Auto Output (Change this to Measure on Poll.)
Distance to Target or Depth output	Distance to Target Depth	Distance to Target
Distance to Ground	Decimal Value in Meters	0.0
Measurement Interval Units	Seconds Minutes Hours	Seconds
Measurement Interval Value	Integer 1-255	60
Output Unit	Meters Centimeters Millimeters Feet Inches	Meters
Setting Description	Options	Default Value
Quality Output	On Off	Off (Change this to ON.)
Temperature Output	On Off	Off Output valid only for the SR50AT
Diagnostics Output	On Off	Off (Change this to ON.)

D.4.1 Baud Rate Setting

The factory default baud rate setting of 9600 bps is suitable for most applications. Lower baud rates (1200 or 4800 bps) may improve communication reliability or allow for longer cable lengths. Higher baud rates (19200 or 38400 bps) may be used where faster communications are required.

The quiescent current draw for the SR50A in serial mode is normally 1.25 mA for baud rates of 9600 or less. The current draw increases to 1.5 and 2.25 mA for the baud rates of 19200 or 38400 bps, respectively.

It is possible to download a firmware update to the SR50A via the RS-232 or RS-485 communication interface. Higher baud rates may be desirable to speed up this process.

It may take up to 30 minutes using a speed of 1200 bps, 7 minutes using 9600 bps, or 3 minutes using 38400 bps.

D.4.2 Address

The factory default address is 33. For RS-232 applications, use the factory default address. For RS-485 operation, multiple sensors can be polled individually if different addresses are assigned.

D.4.3 Operational Mode Setting

Three different operational mode settings are available on the SR50A. Overall system design and desired performance determine which mode to select. The SR50A operation for each of the three different modes are described below as well as the advantages and disadvantages of each mode.

D.3.3.1 Measure in Poll Mode

In this mode, the SR50A remains idle until a measurement command is sent (*p33<CR>*) where 33 is the default serial address. After receiving the measurement command, the SR50A immediately begins a measurement and transmits the resulting data packet when the measurement is complete. Typically, the SR50A transmits the data packet within 1 second of receiving the command packet.

- The SR50A only performs a measurement when requested.
- The data output will lag the measurement command by 1 second.
- This configuration is conducive to a multidrop RS-485 system where individual sensors do not transmit data until they are addressed.

D.3.3.2 Auto Measure Auto Output Mode

In this mode, the SR50A automatically exits its low power mode, initiates a measurement, and outputs the data. The frequency that the SR50A performs these functions is set by adjusting the *Measurement Interval Units* and the *Measurement Interval Value* parameters.

- No command is required from an external device to obtain a measurement.
- The data recorder or equipment simply needs to read the incoming serial data from the SR50A.

D.3.3.3 Auto Measure Polled Output Mode

In this mode, the SR50A automatically exits its low power mode and initiates a measurement. The output data string is not sent until a poll command is received. When a poll command is received by the SR50A, the output data typically commences 100 ms after the poll command is sent.

The frequency that the SR50A performs the measurement is set by adjusting the *Measurement Interval Units* and the *Measurement Interval Value* parameters.

- The main advantage of this operating mode is that the receiving device will only have to wait 100 ms for the data instead of 1 second.
- This configuration is also more conducive to a multidrop RS-485 system where individual sensors do not transmit until they are addressed.

D.4.4 Distance to Target or Depth

The SR50A can output either distance to target values or calculate snow depth values. To obtain a valid snow depth value the parameter distance to ground must be entered in.

The SR50AT will compensate the readings for temperature.

Do not use this option on the SR50A sensor unless the SR50A is sent valid temperature reading via the *Temperature Input* command.

D.4.5 Distance to Ground

A valid distance to ground must be entered when the SR50A is configured to output snow depth values. The value must be in meters regardless of the output units that are selected.

If the exact value cannot be obtained, it is better to slightly overestimate the value rather than underestimating it. If a **Distance to Ground** value is too small, the SR50A will output an error value as the snow surface should not be below the ground surface.

D.4.6 Measurement Interval Units

This setting is only applicable if either the *Auto Measure Polled Output* or the *Auto Measure Auto Output* modes are used. The options for the *Measurement Interval Units* are:

- Seconds
- Minutes
- Hours

Once a unit type is selected, the number of units for the interval is set by changing the *Measurement Interval Value* parameter. A 60 s interval can be set by setting the units to seconds and the *Measurement Interval Value* to 60. Alternately, the *Measurement Interval Unit* could be set to minutes and the *Value* could be set to 1. The *Value* setting can only range from 1 to 255.

D.4.7 Measurement Interval Value

This setting is only applicable if either the *Auto Measure Polled Output* or the *Auto Measure Auto Output* modes are used. The *Measurement Interval Value* can range from 1 to 255. The units used for the value is set by the *Measurement Interval Units*.

D.4.8 Output Unit

The SR50A always outputs the distance to the target. The units for the distance value can be set to any of the following values:

- Meters
- Centimeters
- Millimeters
- Feet
- Inches

D.4.9 Quality Output

The SR50A quality numbers can be optionally included in the data output string. The *Quality Output* setting can be set to **ON** or **OFF**.

D.4.10 Diagnostics Output

The SR50A diagnostics numbers can be optionally included in the data output string. The *Diagnostics Output* setting can be set to **ON** or **OFF**.

D.5 Serial Commands

D.5.1 Setup Command

The setup command places the SR50A in the serial setup mode. This command should only be sent to customize a sensor's settings. Upper and lower case letters are accepted and a carriage return character must also terminate the string.

“setup<CR>”

D.5.2 Poll Command

The poll command is used to obtain the sensor's output values. The poll command consists of the upper or lower case letter “p” followed by the SR50A address (default 33). The command must also terminate with a carriage return character.

“pAA<CR>” – where AA is a two-character address and set from the factory to 33

“p33<CR>” – Poll command with factory address of 33

D.5.3 Information Command

The information command is used to query information from the sensor that is not associated with the sensor's output. For detailed information on the output refer to Section 9.2.1, *Data Interpretation* (p. 18).

The information command consists of the upper or lower case letter “i” followed by the SR50A address (default 33). The command must also terminate with a carriage return character.

“iAA<CR>” – where AA is a two-character address and set from the factory to 33

“i33<CR>” – information command with factory address of 33

D.5.4 Temperature Input Command

The temperature input command is used to send the SR50A version of the sensor a temperature value that is to be used for temperature compensation. The value sent must be in degrees Celsius and should not exceed eight characters.

The command consists of the upper or lower case letter “t” followed by the SR50A address (default 33) a semicolon and the temperature value. The command must also terminate with a carriage return character (Enter for Hyperterminal).

“tAA;-5.5<CR>” – where AA is a two-character address and set from the factory to 33 and -5.5 is the temperature in degrees C

“t33;tt.ttt<CR>” – Temperature command with factory address of 33 and a temperature value in Celsius.

D.6 RS-232/RS-485 Data Output Format

D.6.1 Measurement Output

The measurement output string for the SR50A is as follows:

<STX>aa;D.DDD;QQQ;TT.TT;VVVVV;CC<CR><LF><ETX>

<STX> is the hex character &h02 (2 in decimal)

aa

These two characters are the serial address of the sensor. The default is 33. Note this is two ASCII characters of &h33 in hexadecimal or 51 in decimal.

D.DDD

This is the distance to target reading. The units depend on the *Output Units* setting. The number of digits and decimal places also depend on the output unit that is selected. The decimal digits are as follows:

Meters:	D.DDD, 0.000 for no valid reading DD.DDD possible for values past 9.999 m
Centimeters:	DDD.DD DDDD.DD possible for values past 999.99 cm 000.00 output for no valid reading
Millimeters:	DDDD -999 output for no valid reading 9999 Maximum value
Feet:	DD.DDD 00.000 output for no valid reading

Inches: DDD.DD
 000.00 output for no valid reading

QQQ

This data value is the optional quality value output. The quality value is always a three-digit integer and varies from 152 to 600, where 600 is the poorest quality.

TT.TT

This setting must be set to **Off**. The SR50A will output a -999.00 if the **Temperature Output** option is set to **ON**.

VVVVV

This is the diagnostic output value. Each digit represents a pass or a fail on a diagnostic test.

XVVVV

If X is a 1, then the ROM Memory has passed the signature test.

VXVVV

If X is a 1, then no watchdog errors have occurred.

VVXXX

The three digits XXX are for factory use and should always read 111.

CC

This is a two-character checksum of the data packet. The checksum is the two's complement of the data packet sum including control characters.

The Least significant byte is used resulting in a two-character checksum.

<STX> = &h02 (Hexadecimal)
 <CR> = &h0D (Hexadecimal)
 <LF> = &h0A (Hexadecimal)
 <ETX> = &h03 (Hexadecimal)

The following is a sample packet with proper checksum:

<STX>33;1838;194;11011;2C<CR><LF><ETX>

SUM =

02+33+33+3B+31+38+33+38+3B+31+39+34+3B+31+31+30+31+31
 +3B+0D+0A+03
 =0x3D4

Use Last byte only (D4) and calculate two's complement = 100 - D4 = 2C

<CR>

Carriage return character. 0x0d in hexadecimal or 13 in decimal

<LF>

Line feed character. 0x0a in hexadecimal or 10 in decimal

<ETX>

End of transmission character. 0x03 in hexadecimal or 3 in decimal

D.6.2 Information Message Output

The measurement output string for the SR50A is as follows:

<STX>aa;SSSS;H.H;F.F;BBBBB;WWWWW<CR><LF><ETX>

<STX> is the hex character 0x02 (2 in decimal)

aa

These two characters are the serial address of the sensor. The default is 33. Note this is two ASCII characters of 0x33 in hexadecimal or 51 in decimal.

SSSS

This is the serial number of the sensor.

H.H

This is the hardware version of the sensor.

F.F

This is the firmware version of the sensor.

BBBBB

This is the checksum of the boot code.

WWWWW

This is the checksum of the firmware.

CC

This is a two-character checksum of the data packet. The checksum is the two's complement of the data packet sum including control characters.

The least significant byte is used resulting in a two-character checksum.

<STX> = &h02 (hexadecimal)

<CR> = &h0D (hexadecimal)

<LF> = &h0A (hexadecimal)

<ETX> = &h03 (hexadecimal)

The following is a sample packet with proper checksum:

<STX>33;1838;194;11011;2C<CR><LF><ETX>

SUM =

02+33+33+3B+31+38+33+38+3B+31+39+34+3B+31+31+30+31+31

+3B+0D+0A+03

=0x3D4

Use Last byte only (D4) and calculate two's complement = 100 - D4 = 2C

<CR>

Carriage return character. &h0D in hexadecimal or 13 in decimal

<LF>

Line feed character. &h0A in hexadecimal or 10 in decimal

<ETX>

End of transmission character. &h03 in hexadecimal or 3 in decimal

Appendix E. Tera Term QuickStart

Tera Term can be used to configure the RS-232 or RS-485 settings or to update the sensor's firmware. *Tera Term* is a powerful open-source terminal emulation package. It can be accessed from the link below. Pull down and install the latest version.

<https://en.osdn.jp/projects/tssh2/releases/>

E.1 Configure *Tera Term* for Serial 9600 BPS Communication

1. Click on the *Tera Term* icon and bring up the software. *Tera Term* always starts up with the **New connection** window as shown in FIGURE E-1.
 - a. Click on the radio button next to **Serial**.
 - b. Click on the down arrow to the far right of **Port** and pick the **COM port** you are using to communication with the SR50A/T.

NOTE

COM port 4 is used in the examples in this section. Your COM port may be different.

- c. Click on the **OK** button.

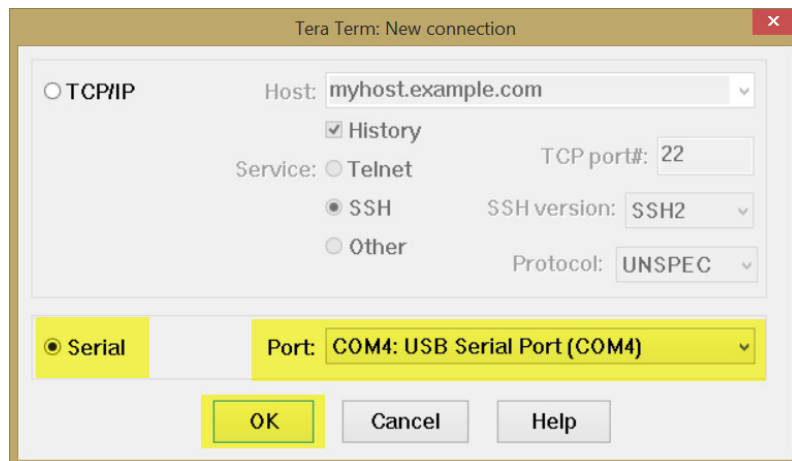

FIGURE E-1. Tera Term New Connection

- FIGURE E-2 shows the standard *Tera Term* working screen and the pull-down menu for **Setup**. To see this screen, click on **Setup** at the top of the screen.

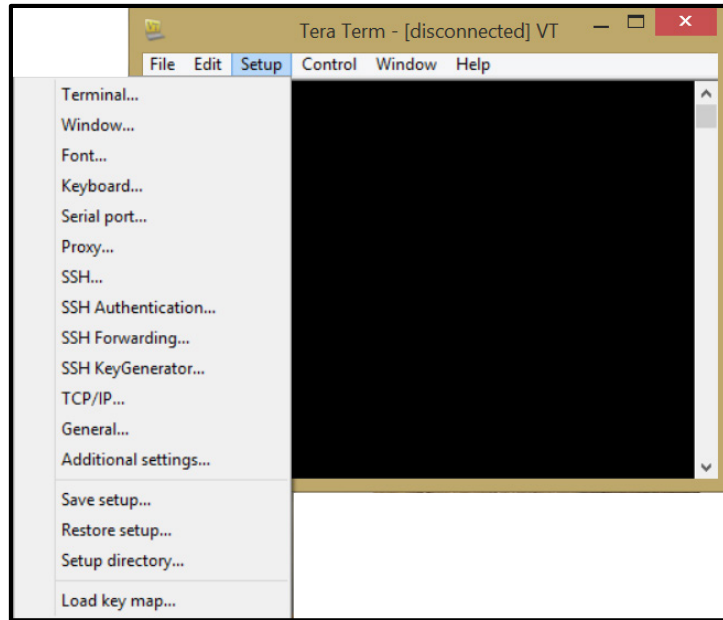

FIGURE E-2. Setup Selections

- Select **Terminal** from the drop-down menu list in **Setup**. The SR50A/T does not echo characters sent to it. To see what you're typing, **Local Echo** needs to be switched on by checking the box next to **Local Echo** (FIGURE E-3). Leave everything else at the default settings. Click on the **OK** button to save the settings or the **Cancel** button to simply exit.

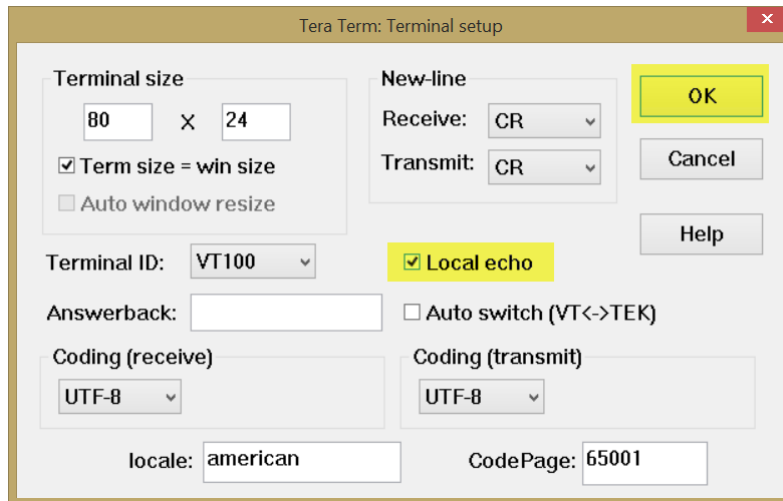

FIGURE E-3. Terminal Configuration

4. Select **Window** from the drop-down menu list in **Setup**. Change the title in the **Window setup** to **SR50A 9600 Baud**. The title is displayed at the top of the terminal session screen.

By default, *Tera Term* works with white characters on a black background, but can be changed to black characters on a white background. To change the settings, click the radio button next to **Background** and click on the **Reverse** button. Click on the **OK** button when finished making changes. See FIGURE E-4.

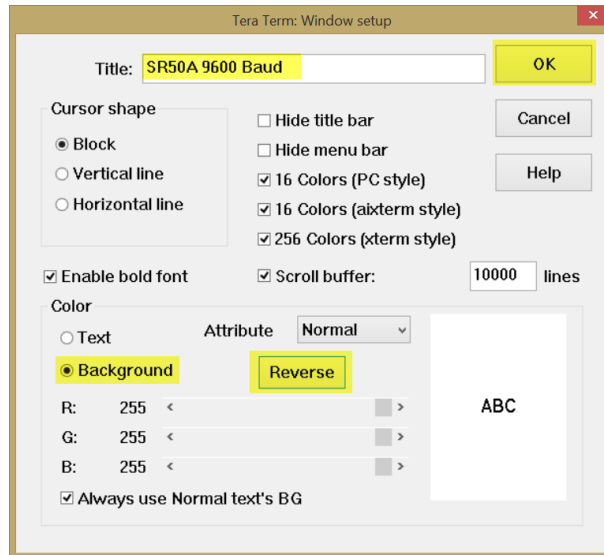

FIGURE E-4. Windows Setup Changes

5. By default, *Tera Term* uses a font size of 9. If a larger font size is desired, select **Font** from the drop-down list in **Setup**. Under **Size**, select the desired font size. FIGURE E-5 shows the selection of 12 for the font size. Click on the **OK** button when finished.

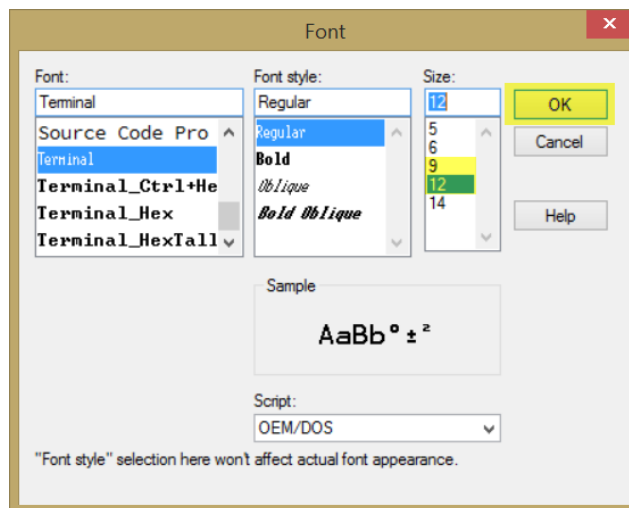

FIGURE E-5. Setting the Font Size

6. Select **Serial port** from the drop-down list in **Setup**. Change the port to reflect what you will be using to work with the SR50A/T. Leave the other settings at their default values. Click the **OK** button when finished (FIGURE E-6).

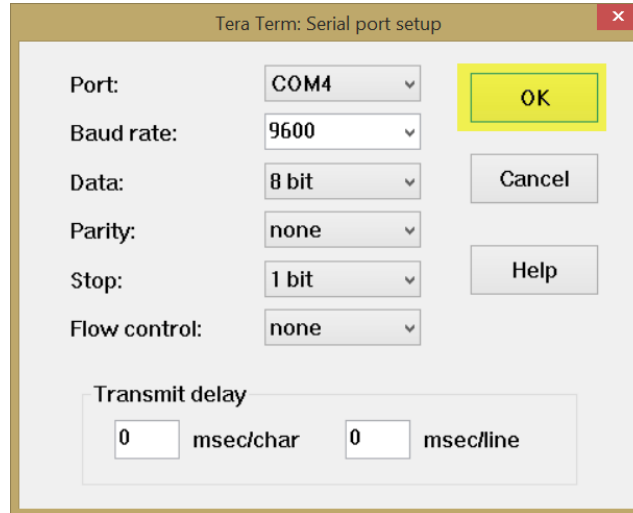

FIGURE E-6. Configuring the Serial Port

7. All changes needed to work with the SR50A/T are complete. You are back at the main screen with the cursor blinking in the upper left corner of the window. To see if communication has been established with the SR40A/T, type **setup** and press **enter**. The word **setup** should appear in the terminal window and the SR50A/T setup window should appear as well (FIGURE E-7).

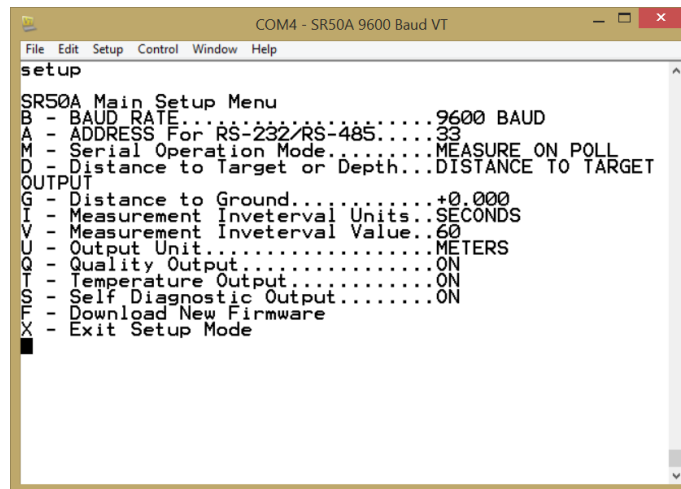

FIGURE E-7. Testing the Configuration

8. To save this setup configuration, or any configuration, select **Setup** from the top of the screen and select **Save setup** from the drop-down menu. Give the file a name and save it to your **Documents** folder in *Windows*.
9. To load an existing setup, select **Setup** from the top of the screen. Select **Restore setup** from the list and select the setup configuration that you would like to load. *Tera Term* will not automatically connect to a COM port and will remain disconnected until a COM port is selected. To do this, select **Serial port** from the **Startup** drop-down menu. Verify the COM port selection is correct and click on the **OK** button. This will activate the port.

E.2 Firmware Update

E.2.1 Configure *Tera Term* to Send SR50A/T Firmware Update

Device Configuration Utility cannot be used to send a firmware update to a SR50A/T.

General setup requires the following COM port configuration:

- BAUD rate: 38400
 - Data Bits: 8
 - Parity: None
 - Stop Bits: 1
 - Flow Control: XON/XOFF
 - 25 ms line delay
1. To configure *Tera Term*, follow steps 1 through 3 from Appendix E.1, *Configure Tera Term for Serial 9600 BPS Communication* (p. E-1).
 2. Select **Window** from the drop-down menu list in **Setup** and change the title to **SR50A/T Firmware Download**. The title is displayed at the top of the terminal session screen.
 3. Configure the serial port as follows (FIGURE E-8).
 - a. Click on the down arrow to the right of **Baud rate** and select **38400**.
 - b. Click on the down arrow to the right of **Flow control** and select **XON/XOFF**.
 - c. Enter **25** into the box to the left of **msec/line**.
 - d. Click on **OK** when all changes have been made.

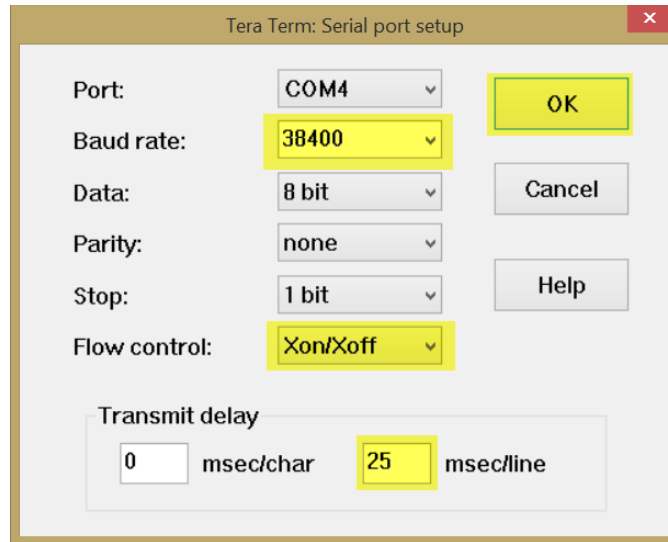

FIGURE E-8. Configuring the Com Port to Send an Operating System

E.2.2 Sending New Firmware to a SR50A/T Sensor

Download a new firmware update from Campbell Scientific's website, www.campbellsci.com. Copy the TXT file to the `C:\CAMPBELLSCI\Lib\OperatingSystems` folder. For this example, the file `SR50A_May_29_2007_V_1_3.TXT` will be sent to a SR50AT. This firmware update is used for either the SR50A or SR50AT.

To send a firmware update to the SR50A/T, the jumpers must be configured for RS-232 operation and the jumper moved from **RUN** to **PROG**. See FIGURE E-9 below.

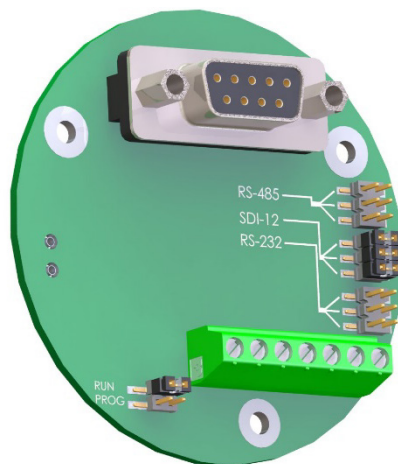

FIGURE E-9. Jumper Settings

Firmware updates should only be performed at an appropriate workstation with static control procedures in place. Failure to follow the procedure may cause damage to the sensor.

1. Ensure the SR50A/T is completely disconnected from power or communication. The best way to do this is to simply unscrew the cable connector from the SR50A/T.
2. Open the SR50A/T as follows:
 - a. Remove the six Phillips screws (slot-headed screws in older models) that are located on the bottom side of the transducer housing.
 - b. The transducer housing will separate from the main metal housing.
 - c. Ensure that the screws are kept and set aside. On older models, the O-ring is removable. Remove the O-ring and set it aside as well.
 - d. Disconnect the transducer housing assembly from the main metal body by pressing down on the tab on the connector and gently pulling the connectors apart. You may have to gently rock the connector from side to side to get it to separate.
 - e. Remove the two Phillips screws from the bottom of the disk assembly. Notice that these are the only two countersunk holes in the disk assembly. Set the two screws aside.
 - f. The bottom disk assembly and the transducer housing have a V-shaped notch that lines up with a mating V in the metal housing. Separate the bottom disk from the main metal housing.
 - g. The circuit board will remain connected to the housing via the signal wires.
 - h. Place the bottom disk/circuit assembly on the work bench with the circuit board and DB-9 connector facing up. Ensure that no part of the PCB is in contact with the metal lid or other conductive objects.
3. Move the jumper on the RUN/PROG header from the RUN position to the PROG (program) position.
4. Connect to the DB-9 connector on the SR50A/T PC board.
5. Connect the cable back to the SR50A/T. The cable should be providing the SR50A/T with power.
6. When power is reestablished, you will see a green LED light up close by the RUN/PROG jumper. The LED will be on continuously with no flashing.
7. Connect to the SR50A/T with *Tera Term*.

NOTE

The SR50A/T will not accept any commands when in the program mode.

8. In *Tera Term* select **File** at the top of the screen.
9. From the drop-down menu select **Send file...**

10. Find the new firmware file and click **Open**. See the figure below.

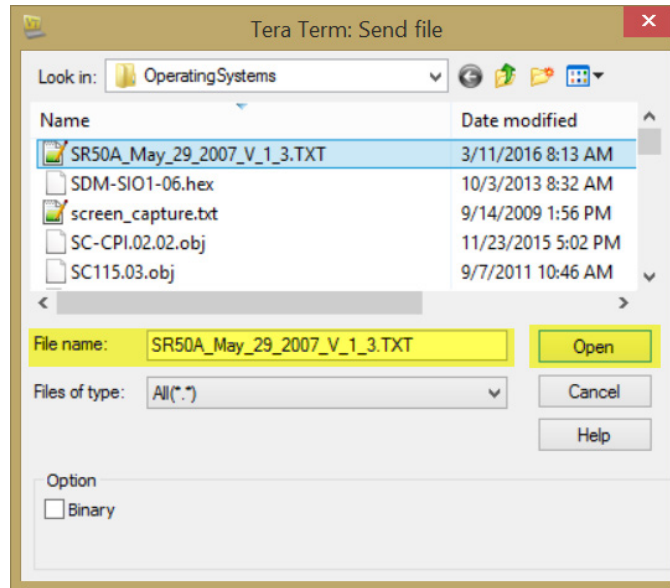

11. *Tera Term* immediately begins sending the file when **Open** is selected. The following will happen at this point:

- a. The green light on the SR50A/T will start flashing and continue to flash for several minutes after the file has been sent.
- b. You will see the following screen indicating that the transfer process is occurring in *Tera Term*. Directly above the **Send File** window, you will see the lines of code being sent to the SR50A/T. Do not click on any of the buttons in the **Send File** window. The window will automatically disappear after the file has been sent.

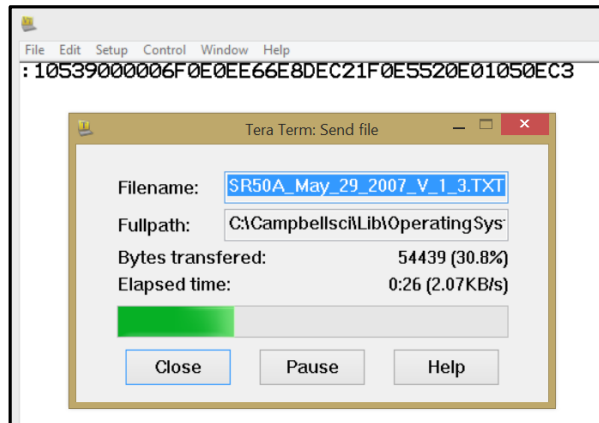

The green light on the SR50A/T will continue to flash for several minutes after the file has been sent. When the new firmware is loaded and operational, the green light will come on steady. If there are any errors, the LED will flash indicating that an error occurred.

12. If the LED does flash, then repeat the process and attempt to send the firmware again.

13. After the reprogramming is successful, disconnect power from the sensor and disconnect the serial cable from the DB-9 connector.
14. Move the jumper from **PROG** back to **RUN**.
15. Reassemble the sensor.
 - a. Line up the notch on the disk/circuit assembly with the V in the main metal housing. Do not kink the wires going from the disk/circuit assembly to the main metal assembly. Seat the disk/circuit assembly. Put the two Phillips screws back in the countersunk holes. Do not over tighten the screws. They should be snug.
 - b. Older transducer heads use a removable O-ring. Carefully seat the O-ring back into place and make sure you won't cut it when assembling the transducer assembly.
 - c. Line up the connector on the transducer housing with the mating connector on the disk/circuit assembly and slide it into place until the tab clicks into place.
 - d. Line up the notch on the transducer housing with the V on the main metal housing. Seat the housing.
 - e. Put the six screws back into the bottom of the transducer and tighten them down.
16. Verify operation of the sensor by obtaining a measurement.

Appendix F. SR50AH Heater Operation

The heater option on the SR50AH is intended for installations where rime ice is problematic. The heater will help to prevent the ice from forming on the transducer, which can impair proper operation of the sensor.

The heater option is easily identifiable as the transducer housing contains a cable port for the heater supply cable.

Always use the heater option wired to switched 12 Vdc source. For battery-operated solar-powered sites, Campbell Scientific recommends that the heater's power be turned off when icing conditions are not occurring to reduce power requirements. The heater power must be turned off when operating at temperatures of 25 °C or more.

CRBasic programs that control the heater are provided in Appendix B.4, *Heater Program Examples (p. B-16)*.

F.1 Heater Specifications

Heater Resistance:	75 Ω
Nominal Operating Voltage:	12 V (ac or dc); use a properly conditioned, low-noise power source. A noisy power source will affect operation of the sensor.
Maximum Rated Wattage:	3 W
Maximum Rated Voltage:	15 V (ac or dc)
Maximum Operating Temperature:	25 °C; turn the heater power off at temperatures above 25 °C. This prevents damage to the sensor and reduces power consumption.

F.1.2 Heating Cable Requirements

Type:	2 conductor (twisted pair), Shielded
Diameter:	4 to 6 mm (0.16 to 0.24 in)
Recommended Gage:	22 AWG for lengths < 30 m (100 ft)



FIGURE F-1. SR50AH Heater Option

F.2 Heater Maintenance

Most of the maintenance is the same as the maintenance for the standard SR50A (Section 9, *Maintenance and Troubleshooting* (p. 15)). However, the transducer and desiccant replacement is slightly different for the SR50AH. When ordering replacement transducers, ensure that the Replacement Transducer Maintenance Kit (pn 32571) is ordered.

The procedure to disassemble the SR50AH for desiccant replacement or transducer replacement is as follows:

1. Remove the six Phillips screws on the outermost hole pattern.

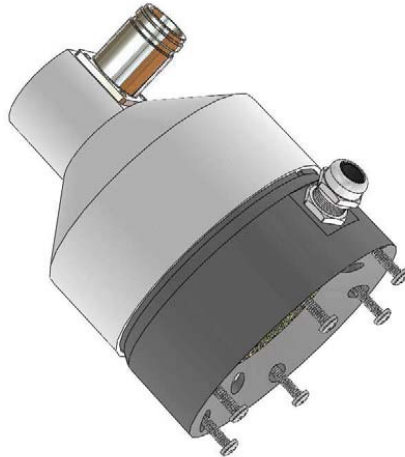

NOTE

The screws used on the SR50A have changed from the slotted type to Phillips.

2. Separate the housing from the sensor body and disconnect the connector from the transducer to the main sensor body.

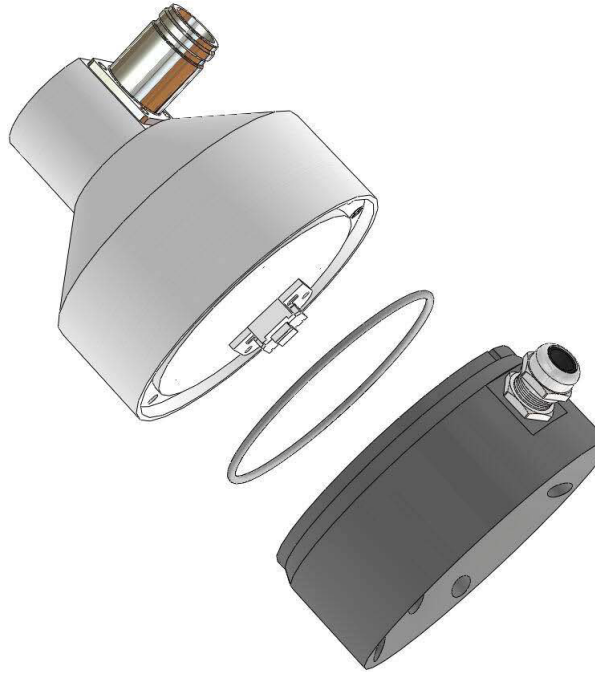

3. To replace the desiccant, remove the desiccant holder plate with the Phillips 4-40 screw. Cutting the tie strap will allow the old packets to be removed for replacement. During reassembly, ensure that the desiccant does not come in contact with the metal backing of the transducer. If only the desiccant is being inspected or replaced, steps 4 and 5 are not required. Steps 4 to 6 are required to replace the transducer only.

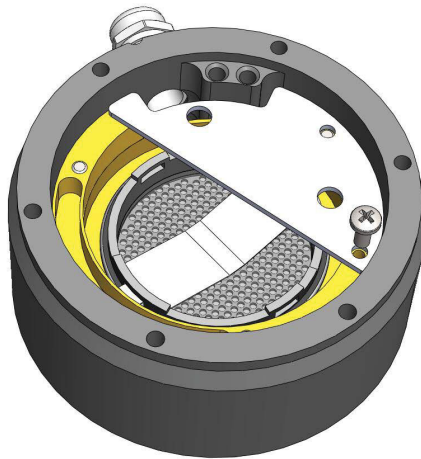

4. Your transducer kit comes with a replacement for the O-ring that seats between the main sensor body and the plastic transducer housing. Ensure that the new O-ring is used when reassembled.

5. Remove the three screws from the innermost hole pattern as shown.



6. Replace the transducer assembly and the second O-ring that seats under the transducer assembly.
7. Reassemble the sensor in the reverse order. Please observe the orientation of the parts, wiring, and desiccant.

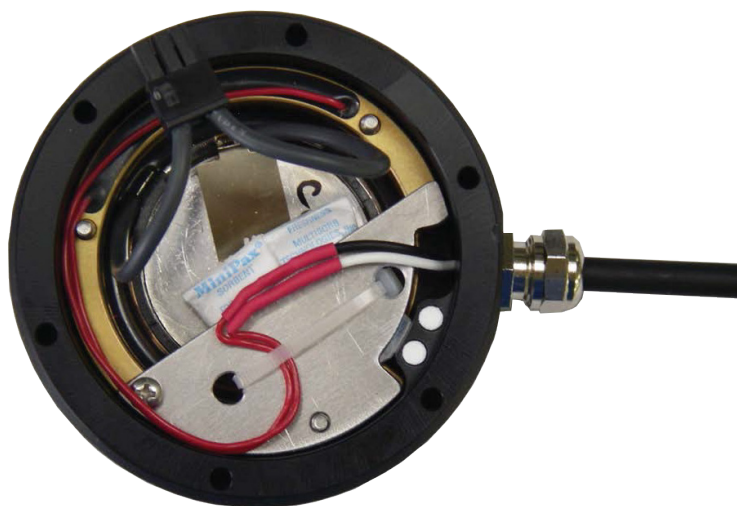

FIGURE F-2. Complete Transducer Assembly with Power Connection

Campbell Scientific Companies

Campbell Scientific, Inc.

815 West 1800 North
Logan, Utah 84321
UNITED STATES

www.campbellsci.com • info@campbellsci.com

Campbell Scientific Canada Corp.

14532 – 131 Avenue NW
Edmonton AB T5L 4X4
CANADA

www.campbellsci.ca • dataloggers@campbellsci.ca

Campbell Scientific Africa Pty. Ltd.

PO Box 2450
Somerset West 7129
SOUTH AFRICA

www.campbellsci.co.za • cleroux@csafrica.co.za

Campbell Scientific Centro Caribe S.A.

300 N Cementerio, Edificio Breller
Santo Domingo, Heredia 40305
COSTA RICA

www.campbellsci.cc • info@campbellsci.cc

Campbell Scientific Southeast Asia Co., Ltd.

877/22 Nirvana@Work, Rama 9 Road
Suan Luang Subdistrict, Suan Luang District
Bangkok 10250
THAILAND

www.campbellsci.asia • info@campbellsci.asia

Campbell Scientific Ltd.

Campbell Park
80 Hathern Road
Shepshed, Loughborough LE12 9GX
UNITED KINGDOM

www.campbellsci.co.uk • sales@campbellsci.co.uk

Campbell Scientific Australia Pty. Ltd.

PO Box 8108
Garbutt Post Shop QLD 4814
AUSTRALIA

www.campbellsci.com.au • info@campbellsci.com.au

Campbell Scientific Ltd.

3 Avenue de la Division Leclerc
92160 ANTONY
FRANCE

www.campbellsci.fr • info@campbellsci.fr

Campbell Scientific (Beijing) Co., Ltd.

8B16, Floor 8 Tower B, Hanwei Plaza
7 Guanghua Road
Chaoyang, Beijing 100004
P.R. CHINA

www.campbellsci.com • info@campbellsci.com.cn

Campbell Scientific Ltd.

Fahrenheitstraße 13
28359 Bremen
GERMANY

www.campbellsci.de • info@campbellsci.de

Campbell Scientific do Brasil Ltda.

Rua Apinagés, nbr. 2018 – Perdizes
CEP: 01258-00 – São Paulo – SP
BRASIL

www.campbellsci.com.br • vendas@campbellsci.com.br

Campbell Scientific Spain, S. L.

Avda. Pompeu Fabra 7-9, local 1
08024 Barcelona
SPAIN

www.campbellsci.es • info@campbellsci.es

Please visit www.campbellsci.com to obtain contact information for your local US or international representative.