

LI-7500

CO₂/H₂O Analyzer

Instruction Manual

LI-COR[®]

Environmental Division

LI-7500



Open Path CO₂/H₂O Analyzer
Instruction Manual

LI-COR[®]

LI-COR[®]

ENVIRONMENTAL DIVISION
SERVING RESEARCHERS IN
BIOLOGICAL SCIENCES

■ LI-COR, Inc.
Environmental Division
4421 Superior Street
Lincoln, Nebraska 68504 USA

■ Phone: 402-467-3376
FAX: 402-467-2800
Internet: envsales@env.lincor.com
E-mail: envsales@env.lincor.com

Declaration of Conformity

Manufacturer's Name: LI-COR, Inc.

Manufacturer's Address: 4421 Superior Street
Lincoln, Nebraska USA 68504

declares that the product

Product Name: Open Path CO₂/H₂O Infrared Gas Analyzer

Model Number(s): LI-7500

Product Options: None

conforms to the following Product Specifications:

EMC: CISPR 11: 1990 / EN 55011:1991 - Group 1, Class A
EN 50082-1 : 1992

IEC 801-2 : 1991 - 15kV Air Discharge, 4kV Contact Discharge

IEC 801-3 : 1984 - 10V/m

IEC 801-4 : 1988 - 0.5kV I/O Lines

1kV Power Lines

Supplementary Information:

The product herewith complies with the requirements of the EMC Directive 89/336/EEC.

October 21, 1999
Document #53-06167



David L. Dilley
Director of Engineering
Environmental Division

NOTICE

The information contained in this document is subject to change without notice.

LI-COR MAKES NO WARRANTY OF ANY KIND WITH REGARD TO THIS MATERIAL, INCLUDING, BUT NOT LIMITED TO THE IMPLIED WARRANTIES OF MERCHANTABILITY AND FITNESS FOR A PARTICULAR PURPOSE. LI-COR shall not be liable for errors contained herein or for incidental or consequential damages in connection with the furnishing, performance, or use of this material.

This document contains proprietary information which is protected by copyright. All rights are reserved. No part of this document may be photocopied, reproduced, or translated to another language without prior written consent of LI-COR, Inc.

© Copyright 2001, LI-COR, Inc.
Publication Number 984-06360
Revision 1 - April, 2001
Revision 2 - November, 2002
Revision 3 - July, 2003
Revision 4 - January, 2004

Printing History

New editions of this manual will incorporate all material since the previous editions. Update packages may be used between editions which contain replacement and additional pages to be merged into the manual by the user.

The manual printing date indicates its current edition. The printing date changes when a new edition is printed. (Minor corrections and updates which are incorporated at reprint do not cause the date to change).

Microsoft® and Windows® are registered trademarks of Microsoft Corporation. Eurofast® is a registered trademark of Turck Inc.

LI-COR, Inc. ● 4421 Superior Street ● Lincoln, Nebraska 68504
Phone: 402-467-3576 ● FAX: 402-467-2819
Toll-free: 1-800-447-3576 (U.S. & Canada)
e-mail: envsales@licor.com ● www.licor.com

Table of Contents

Section 1. Introduction

Overview of the LI-7500	1-1
Getting Started Tutorial	1-3

Section 2. Theory of Operation

Relating Absorptance to Concentration	2-1
Measuring Absorptance	2-3
Cross Sensitivity	2-4
Zero Drift	2-5
Equation Summary	2-6
LI-7500 Implementation	2-9
A Note About Pressure and Temperature	2-11

Section 3. Setup and Operation

Installing the LI-7500	3-1
Mounting the Control Box	3-1
Mounting the Sensor Head	3-4
Serial Cable Connection	3-5
6-Pin Eurofast Serial Cable	3-5
LI-7500 Serial Adapter Cable	3-6
Standard Serial Cable	3-7
DAC Cable Connection	3-9
Installing the PC Communications Software on Your Computer	3-10
Operation - Using the <i>LI7500</i> Software	3-10
Connect Page - Establishing Communications	3-11
Calibration Page - Setting the Zero and Span	3-13
Cal Coefficients Page	3-16
Changing Sensor Heads	3-18
Inputs Page - Temperature, Pressure, and Auxiliary Inputs	3-21
Outputs Page - Setting DAC and SDM Outputs	3-28
RS-232 Page - Setting RS-232 Output	3-36
PC Logging Page - Choosing the Values to Log	3-40
Strip Charts Page	3-42
Diagnostics Page	3-45
Menu Description	3-46

Operational Considerations	3-50
----------------------------------	------

Section 4. Calibration

Introduction.....	4-1
How Stable are Zero and Span?	4-2
Checking the Zero - Considerations	4-3
Checking the Span - Considerations	4-3
What Actually Happens	4-4
Complete Step-by-Step Calibration Instructions	4-7

Section 5. Maintenance

Cleaning the Optical Path	5-1
Changing the Fuse	5-3
Replacing the Internal Chemicals	5-4

Section 6. Troubleshooting

Power On Problems	6-1
PC Connection Problems	6-2
Bad Temperature or Pressure Readings	6-3
Bad CO ₂ or H ₂ O Readings	6-4
Diagnostic Messages	6-5
<i>LI7500</i> Error Messages	6-9

Appendix A. Specifications

Appendix B. Pin Assignments

Appendix C. List of Suppliers

Appendix D. Configuration Grammar

Warranty



Introduction

Overview of the LI-7500

The LI-7500 is a high performance, non-dispersive, open path infrared CO₂/H₂O analyzer designed for use in eddy covariance flux measurement systems. Some of the LI-7500's important features include:

- Simultaneous measurements of CO₂ and H₂O in the free atmosphere.
- High speed measurements. Internal 150 Hz measurements are digitally filtered to provide a true 5, 10, or 20 Hz bandwidth.
- Withstands exposure to rain or snow without damage or calibration shift.
- Versatile output options: DACs, SDM, and RS-232.
- Simple Windows[®] software provides for easy user calibration and configuration.

IMPORTANT NOTE! LI-COR Biosciences does not endorse the suitability of the LI-7500 for applications on moving platforms or in applications where the instrument is exposed to corrosive elements (i.e., oceanographic salt water spray). If you have questions about the suitability of the LI-7500 for your application, please contact LI-COR.

If you have just taken delivery of your LI-7500, check the packing list to verify that you have received everything that was ordered and that you have also received the following items:

- **Standard Spare Parts Kit** - (part #9975-007). This kit contains replacement parts for your LI-7500. Among other items, the spares kit contains cables and fuses, serial adapter cable, tubing, and control box mounting brackets. As you become familiar with the analyzer you will learn which items to keep close at hand and which items can be stored away.
- **RS-232 Cables** - (see step 4 in the *Getting Started Tutorial* which follows for information on connecting the LI-7500 to a computer). Three RS-232 cables are included:
 - Part #9975-015 - short cable, to connect the *internal* RS-232 connector to your computer, using #9975-016 (below).
 - Part #9975-016 - 9 pin to 9 pin RS-232 cable.
 - Part #392-05620 - 4m RS-232 cable, unterminated on one end, to connect to the *external* port on the LI-7500 control box.

- **Power Cable** - (part #392-05619). 4m cable used to connect the LI-7500 to your 10.5-30VDC power supply.
- **SDM Interface Cable** - (part #392-05618). Used to connect the LI-7500 in a Synchronous Device for Measurement (SDM) loop, such as those used by Campbell Scientific data recording devices. Longer cables can be ordered from Turck Inc. (see Appendix C).
- **Analog Input Cable** - (part #392-05621). Used to connect external temperature and/or pressure transducers to the LI-7500. See *Calibration* Section 4 for details.
- **DAC Output Cable** - (part #392-05622). Used for DAC outputs from the LI-7500.
- **LI7500 Data Communications Software** - (part #7500-50). This Windows® 95/98/NT compatible software allows your computer to communicate with the LI-7500. The software is provided on CD. A complete description of this software can be found in Section 3, *Setup and Operation*.
- **Calibration Accessory** - (part #9975-012). Contains a calibration tube required for setting the zero and span of the LI-7500. Complete calibration instructions can be found in Section 4.

- **Calibration Sheet** - Contains the calibration coefficients for your LI-7500 sensor head. These values are unique to each sensor head, and have been entered into the control box at the factory. Keep this sheet in case you need to re-enter these values.

Getting Started Tutorial

The following section briefly covers the basic steps you might follow to set up the LI-7500 to collect and record data. Many of these steps are described in greater detail elsewhere in this manual.

1

Connect the Sensor Head

The LI-7500 sensor head is connected to the control module via a 3m (10') shielded cable. The cable has a circular connector which is attached to the sensor head as shown in Figure 1-2. Align the red marks on the cable connector and the sensor head, and push straight in. To unplug the connector, pull straight out. *Do Not Twist!*

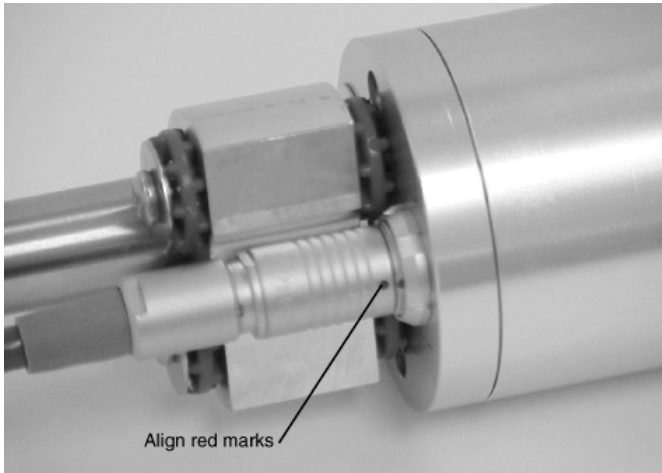

Figure 1-1. Align the marks and insert the cable connector.

2

Connect the Power Supply

The power supply cable (#392-05619) has a circular connector that attaches to the LI-7500 control unit front panel at the location shown in Figure 1-2. The other end has bare wire leads for connection to a 10.5-30VDC supply (2A or greater). Connect the red/white lead to the positive terminal of the power supply, and the green wire to the negative terminal.

3

Install the *LI7500* PC Communications Software

This software is required for communicating with a computer. Installation instructions can be found in Section 3, *Installing the PC Communications Software on Your Computer*.

4

Connect the RS-232 Cables

For convenience when operating the LI-7500 in the laboratory, a short adapter cable (#9975-015) is provided for connecting the instrument to your computer.

- a. Open the control box.
- b. Unplug the internal RS-232 connector from the board, as shown in Figure 1-2.
- c. Plug the 9975-015 adapter cable (Figure 1-2) into this connector.
- d. Connect the DB-9 end of the adapter cable to your computer using the 9975-016 cable.

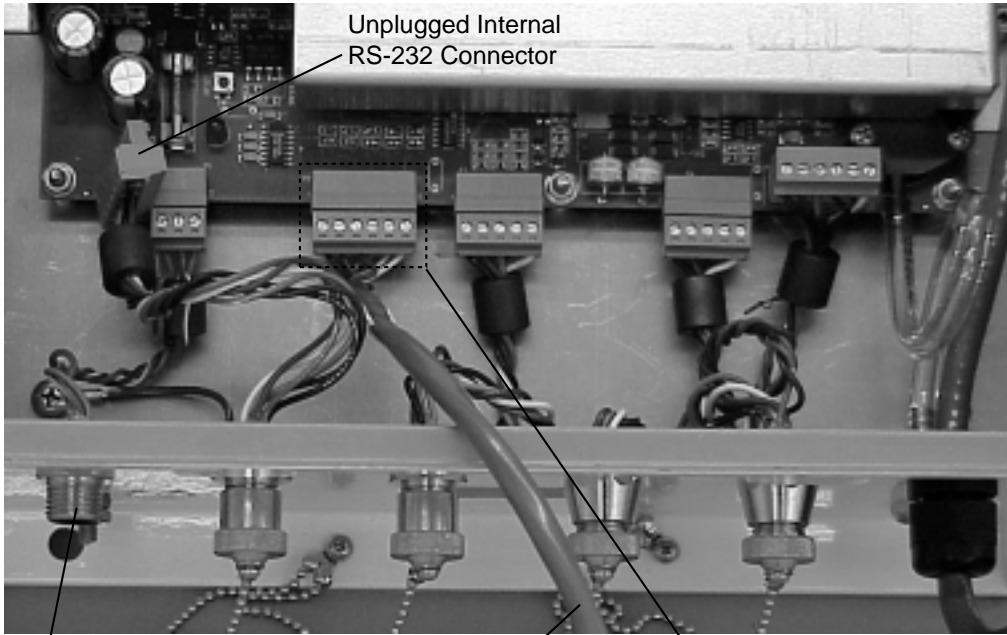
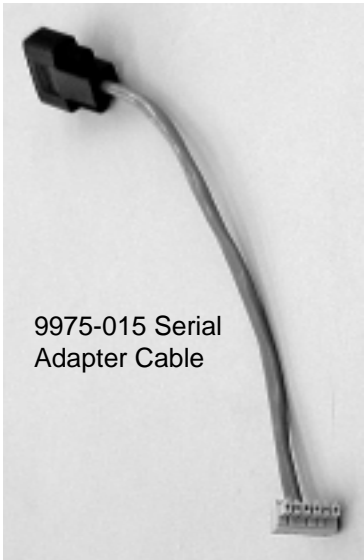

Figure 1-2. Unplug the internal RS-232 connector, and plug in the adapter cable.

5

Start the LI-7500 Communications Program

Open the *LI7500* Windows Communications program. Choose the COM (serial) port to which the RS-232 cable (Step 4) is connected to the computer, select a baud rate, and click on **Connect**. After a few seconds, you should see "live" numbers on the display.

6

Verify Calibration Coefficients

Click on the *Cal Coeffs* tab in the *LI7500* program and verify that the information on this page matches what is printed on the calibration sheet for the sensor head being used. (Sensor heads are interchangeable, but the calibration coefficients, as well as the zero and span parameters on the *Calibration* page, are unique to each sensor head).

7

Verify Temperature and Pressure

Click on the *Calibration* tab, and verify that reasonable values are being displayed for 'Temperature (°C)' and 'Pressure (kPa)'. If there appears to be a problem, see "Bad Temperature or Pressure Readings" in Section 6, *Troubleshooting*.

8

Verify CO₂ and H₂O Response

If the sensor head is indoors, it may be reading very high values of CO₂; if you exhale toward the sensor head, CO₂ and H₂O should show a sudden spike upward.

9

Verify AGC

Click on the *Diagnostics* tab, and view the AGC value. Make a note of this value, as it represents the "clean window" baseline value (assuming your instrument is new). Typical "clean window" values are 55 to 65%. As dirt accumulates on the windows (or anywhere in the optical path), the AGC value will increase to 100%. The instrument will still function correctly at 100%, but there is not much room for further compensation, so the windows should be cleaned before it reaches 100%.

10

(Optional) Verify Calibration

If you have facilities to check zero and span, do so now (see Section 4, *Calibration*). This was done at the factory prior to shipping, so should not be necessary on new instruments*. Note the zero values for CO₂ and H₂O, if this is a new instrument. As the internal chemicals become depleted, these values will increase (when you re-zero).

* If you find the span needs re-setting, it is possible that your CO₂ (or H₂O) standards differ from LI-COR's.



Theory of Operation

Relating Absorption to Concentration

The scaling law of Jaimeson et. al. (1963) shows the effect of pressure on infrared absorption. If the amount of absorber of some gas u_i (mol m^{-2}) and absorption in a band are related by some function $h_i()$, then

$$\frac{\alpha_i}{P_{ei}} = h_i \left(\frac{u_i}{P_{ei}} \right) \quad 2-1$$

The subscript i denotes a particular (i^{th}) gas. Pressure is denoted as P_{ei} because it is the equivalent pressure for the i^{th} gas. Equivalent pressure is potentially different from total pressure P if there are gases present other than i that affect how the i^{th} gas absorbs radiation.

Section 2

We rewrite this in terms of number density (mol m^{-3}) by introducing a path length λ , and noting that $u_i = \rho_i \lambda$. Substituting this into Equation 2-1, and solving for the number density ρ_i of gas i yields

$$\rho_i = \frac{P_{ei}}{\lambda} h_i^{-1} \left(\frac{\alpha_i}{P_{ei}} \right) \quad 2-2$$

We rewrite Equation 2-2 as

$$\rho_i = P_{ei} f_i \left(\frac{\alpha_i}{P_{ei}} \right) \quad 2-3$$

by combining λ and the inverse $h()$ functions into a new function $f_i()$. The calibration function $f_i()$ is generated by measuring a range of known densities ρ_i and fitting a curve to ρ_i/P_{ei} plotted against α_i/P_{ei} . Since gas standards are not available in “known densities”, the ρ_i values are computed from known concentrations m_i (moles of gas per mole of air) using the ideal gas law

$$\rho_i = m_i \frac{P}{RT} \quad 2-4$$

Measuring Absorbance

Given a source with radiant power Φ , and a detector some distance away, in the absence of reflection, absorbance by gas i can be determined from

$$\alpha_i = 1 - \tau_i = 1 - \frac{\Phi_i}{\Phi_o} \quad 2-5$$

where τ_i is transmittance through gas i , Φ_i is transmitted radiant power in the absorption band with some concentration of gas i present, and Φ_o is the transmitted radiant power in the absorption band with zero concentration of i present. The LI-7500 approximates absorbance by

$$\alpha_i = \left(1 - \frac{A_i}{A_{i_o}} \right) \quad 2-6$$

where A_i is the power received from the source in an absorbing wavelength for gas i , and A_{i_o} is the power received from the source in a reference wavelength that does not absorb gas i . The LI-7500 measures A_i and A_{i_o} alternately 152 times per second.

If we combine Equations (2-6) and (2-3), we can write the full equation for computing molar density from absorbance.

$$\rho_i = P_{ei} f_i \left(\left[1 - \frac{A_i}{A_{io}} z_i \right] \frac{S_i}{P_{ei}} \right) \quad 2-7$$

Note the zeroing term z_i and the span adjustment term S_i in Equation (2-7).

Cross Sensitivity

Because the LI-7500 uses one detector for measuring A_c , A_{co} , A_w , and A_{wo} , (the absorbed and non-absorbed power for CO_2 and H_2O , respectively), there is a slight cross-sensitivity between gases due to imperfections in the detector's frequency (time) response. This varies from detector to detector, but is measured during calibration, and is corrected in software. Equation 2-6 is written as

$$\alpha_i = \left(1 - \left[\frac{A_i}{A_{io}} + X_{ji} \left(1 - \frac{A_j}{A_{jo}} \right) \right] \right) \quad 2-8$$

where X_{ji} is the cross sensitivity response of gas j on gas i (determined during calibration), and A_j and A_{jo} are the absorbed and non-absorbed power for gas j . Equation 2-7 becomes

$$\rho_i = P_{ei} f_i \left(\left[1 - \left(\frac{A_i}{A_{io}} + X_{ij} \left[1 - \frac{A_j}{A_{jo}} \right] \right) \right] z_i \right) \frac{S_i}{P_{ei}} \quad 2-9$$

Zero Drift

Even though the detector and filters are temperature controlled in the LI-7500, the detector is subject to slight temperature drift as ambient temperature changes. This error is directly related to the detector cooler control voltage, which is measured, and thus provides a mechanism for a software "fine tuning".

The zero term z_i is computed from

$$z_i = Z_{io} + Z_i V_d \quad 2-10$$

where V_d is detector cooler voltage, Z_i is the slope of the relationship between V_d and z_i (determined during calibration), and Z_{io} is the zero factor determined when setting the zero.

Equation Summary

H₂O

In the atmosphere, the absorption of radiation by water vapor is not significantly influenced by any other gas, so the effective pressure for water vapor P_{ew} is simply the total pressure P .

$$P_{ew} = P \quad 2-11$$

H₂O absorptance α_w is (from Equations 2-8 and 2-10)

$$\alpha_w = \left(1 - \left[\frac{A_w}{A_{wo}} + X_{cw} \left[1 - \frac{A_c}{A_{co}} \right] \right] \right) (Z_{wo} + Z_w V_d) \quad 2-12$$

where X_{cw} is the cross sensitivity factor for CO₂ on water vapor ("H₂O XS" on the calibration sheet), Z_w is the zero drift coefficient ("H₂O Z" on the calibration sheet).

H₂O number density ρ_w is given by

$$\rho_w = P f_w \left(\frac{\alpha_w S_w}{P} \right) \quad 2-13$$

The coefficients for the 3rd order polynomial $f_w()$ are given on the calibration sheet.

CO₂

The absorption of radiation by CO₂ molecules is influenced by several other gases, including O₂ and H₂O. Since the concentration of H₂O is most variable, it must be accounted for in the equivalent pressure of P_{ec} CO₂. A method of doing this (LI-COR Application Note #116) is

$$P_{ec} = P\psi(m_w) \quad 2-14$$

where

$$\psi(m_w) = 1 + (a_w - 1)m_w \quad 2-15$$

and m_w is the mole fraction of water vapor. a_w has been determined to be 1.15 for the LI-7500.

CO₂ Absorptance α_c is given by

$$\alpha_c = \left(1 - \left[\frac{A_c}{A_{co}} + X_{wc} \left[1 - \frac{A_w}{A_{wo}} \right] \right] \right) (Z_{co} + Z_c V_d) \quad 2-16$$

where X_{wc} is the cross sensitivity factor for H₂O on CO₂ ("CO₂ XS" on the calibration sheet), Z_c is the zero drift coefficient ("CO₂ Z" on the calibration sheet).

CO₂ molar density ρ_c (mmol m⁻³) is

$$\rho_c = P_{ec} f_c \left(\frac{\alpha_c S_c}{P_{ec}} \right) \quad 2-17$$

The coefficients for the 5th order polynomial $f_c()$ are given on the calibration sheet.

LI-7500 Implementation

Atmospheric pressure P_g (kPa) and temperature T_g ($^{\circ}\text{C}$) are measured by sensors in the control box (Figure 2-1). Their values are displayed on the Calibrations page.

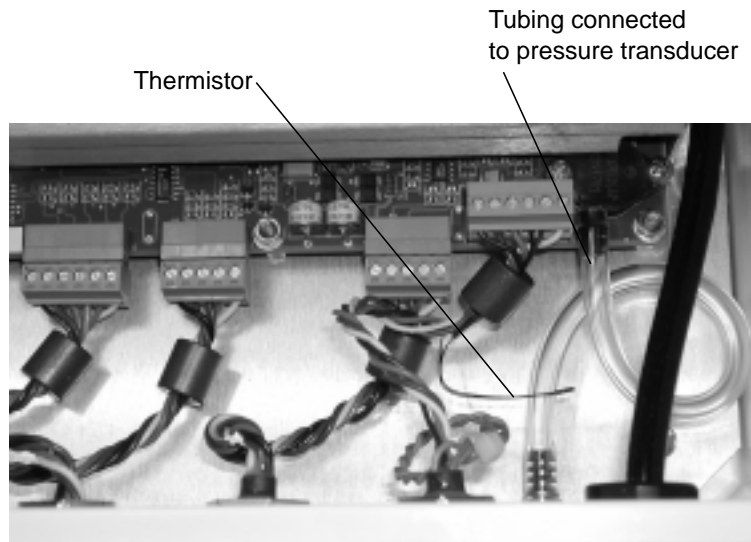

Figure 2-1. Temperature thermistor and pressure sensor location in control box.

Table 2-1. Fundamental equations used in the LI-7500 calculations.

Label	Description	Equation
H ₂ O mmol/m ³	H ₂ O number density	$W = P_g f_w \left(\frac{\alpha_w S_w}{P_g} \right)$ 2-18
H ₂ O g/m ³	H ₂ O mass density	$W_m = \frac{18}{1000} W$ 2-19
H ₂ O mmol/mol	H ₂ O mole fraction	$W_f = \frac{WR(T_g + 273.15)}{1000P_g}$ 2-20
Dew Point (°C)	Dew point temperature	$T_d = \frac{240.97x}{17.502 - x}$ $x = \ln \left(\frac{W_f}{613.65} P_g \right)$ 2-21

Label	Description	Equation
CO ₂ mmol/m ³	CO ₂ number density	$C = P_g \psi \left(\frac{W_f}{1000} \right) f_c \left(\frac{\alpha_c S_c}{P_g \psi \left(\frac{W_f}{1000} \right)} \right) \quad 2-22$
CO ₂ mg/m ³	CO ₂ mass density	$C_m = 44C \quad 2-23$
CO ₂ μmol/mol	CO ₂ mole fraction	$C_f = \frac{CR(T_g + 273.15)}{P_g} \quad 2-24$

$$R = 8.314 \text{ N} \cdot \text{M} \cdot \text{mole}^{-1} \cdot \text{K}^{-1}$$

A Note About Pressure And Temperature

Since the LI-7500 is calibrated for number density, temperature is not required for the calculation, and accurate pressure measurement is not needed either (Equations 2-18 and 2-22). For example, a 5% error in pressure typically leads to a 1% error in density for CO₂. If band broadening effects of water vapor are to be included in the CO₂ number density computation, however, the concentration of water vapor must be known, and this also requires knowing temperature (Equation 2-20). But again, it needn't be known very accurately, since the band broadening correction is fairly small. For example, under the worst conditions (50°C

Section 2

and saturated), a 10 °C error in the temperature measurement would make less than a 0.01% error in the CO₂ number density.

When computing mole fraction, however, temperature and pressure *do* need to be known as accurately as possible. Here, errors in pressure and temperature are directly proportional to errors in mole fraction. For example, in typical conditions, a 1% error in pressure (1 kPa) or a 1% error in temperature (3 °C) will result in a 1% error in concentration (3 to 4 μmol mol⁻¹).



Setup and Operation

Installing the LI-7500

Mounting the Control Box

Brackets are included that can be used to mount the control box using bolts or U-clamps to secure the box to a tripod or other post. There are holes in the four corners of the box, as well, that can be used to attach the box directly to a flat surface, if desired.

The mounting brackets are designed to accommodate a square or circular mounting post of up to 1 1/4" in width (diameter). Use a 3/16" hex key to attach the mounting brackets to the control box. The U-bolt can then be inserted through the holes in the mounting bracket, and tightened around the post, as shown in Figure 3-1.

Section 3

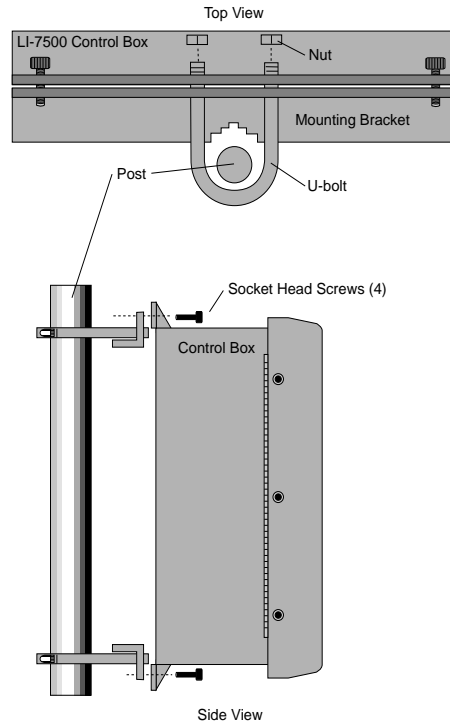

Figure 3-1. Attach mounting brackets to control box, and secure to mounting post.

There are some additional considerations that should be taken into account when locating the control box, including:

1. The cable that connects to the sensor head is 3m in length; determine the height at which the sensor head will be mounted, and plan to mount the control box accordingly.
2. The thermal properties of the control box are such that it is OK to place the box in direct sun.
3. The power cord provided is 4m in length. Longer cables can be purchased through distributors of Turck, Inc. (see *List of Suppliers* in Appendix C). Note, however, that longer cables may require a larger power source.

Mounting the Sensor Head

The LI-7500 sensor head has a mounting post that can be used to mount the analyzer. The mount is threaded to accept standard 3/8-16 tripod screws (a 1/4-20 adapter is also included, which can be threaded into the mounting post). Mounting the sensor head at a slight angle from vertical ($\sim 10\text{-}15^\circ$) may also help prevent water droplets from remaining on the windows during rainstorms.

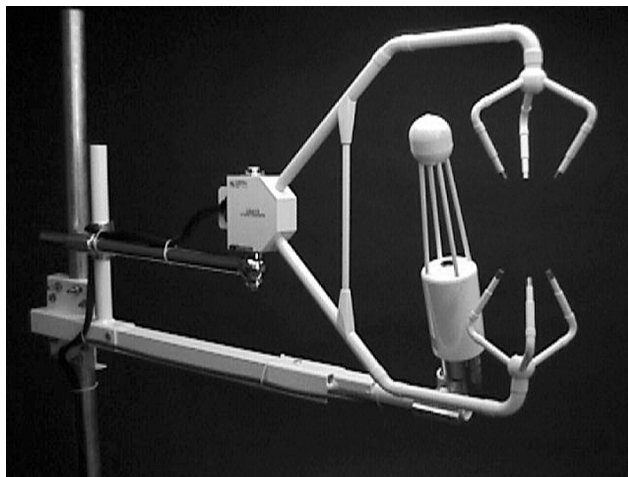
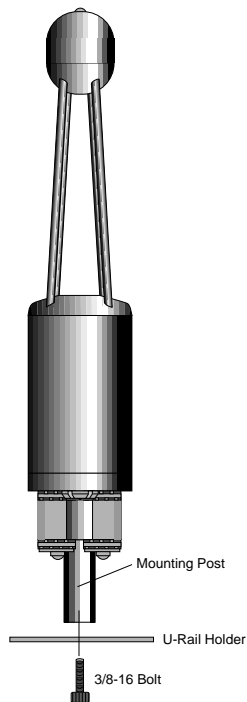

Figure 3-2. Mount the sensor head downwind of the sonic anemometer, at a slight vertical angle.

The sensor head mounting post can also be attached to a U-rail type holder and fastened with a 3/8-16 screw (or a 1/4-20 screw, when using the adapter bushing), as shown above.

A vertical mounting orientation provides 360° acceptance for wind direction (neglecting the sonic anemometer location, of course), and this is the recommended orientation. Note, however, that the LI-7500 will function just fine in any orientation (horizontal, upside down, etc.). A horizontal orientation limits the acceptable wind direction, but reduces problems of rain and dew droplets sitting on the windows. However it is oriented, the sensor head should be placed as close to (and downwind of) the sonic anemometer as possible, and at equal heights, as shown in Figure 3-2.

Serial Cable Connection

There are three serial cables provided for various connection schemes (Figure 3-3). A description of these cables and how to use them is given below.

6-Pin Eurofast® Serial Cable (PN 392-05620)

This 4m cable has a 6-pin circular connector that plugs into the '*Serial Interface*' port on the LI-7500 control unit front panel. The other end has bare wire leads that can be soldered to a standard DB-9 female connector (not included) for direct connection to a computer. This cable is unterminated so that it can be inserted through a hole in a weatherproof box, for example, that contains the logging device. The wire leads should be soldered to a 9-pin connector as described below (see Figure 3-3).

<u>Wire Lead Color</u>	<u>9-Pin Female Connector</u>	<u>9-Pin Male Connector</u>
Black	Pin 5	Pin 5
Brown	3	2
Red	8	7
Blue	2	3
Gray	7	8
White	6	4

LI-7500 Serial Adapter Cable (PN 9975-015)

The Serial Adapter Cable is used to connect to the internal RS-232 connector, located on the PC board, as shown in Figure 1-2. This cable can be used for "in the laboratory" convenience. The Serial Adapter Cable has a 6-pin connector on one end, and a 9-pin DB type connector on the other end, which plugs into the Standard Serial Cable (below). Should one or more of the wires on the 6-pin end become detached, they can be reattached as shown below.

<u>Wire Lead Color</u>	<u>6-Pin Connector</u>
Black	1
Brown	2
Red	3
Blue	4
Gray	5
White	6

Standard Serial Cable (PN 9975-016)

This is a null modem cable that is used to interface with devices such as computers, serial printers, and terminals with 9-pin serial ports. If you want to interface to a device with a 25-pin serial port, then a 9-pin to 25-pin adapter (in the spares kit) must be used.

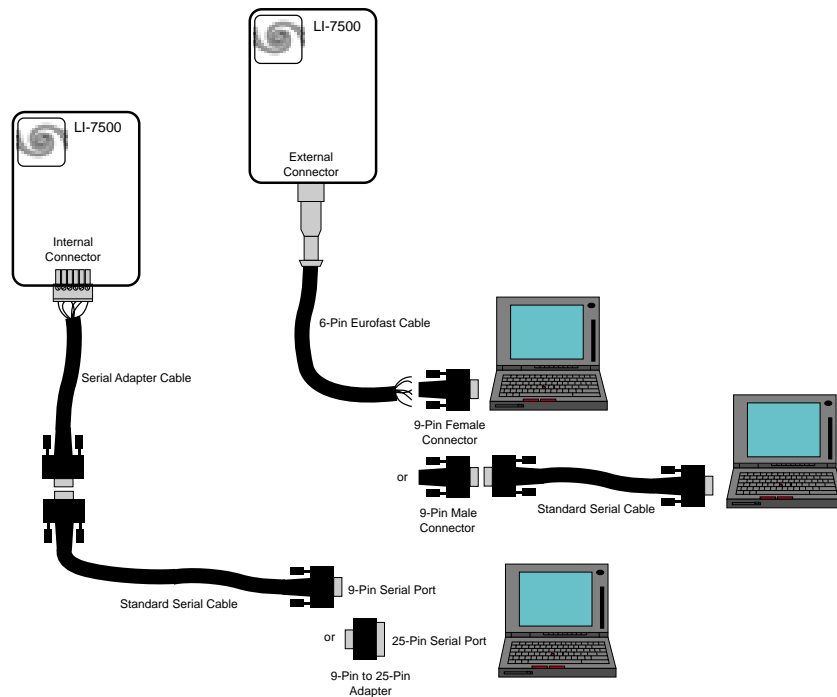

Figure 3-3. Schematic diagram of typical LI-7500 RS-232 cable configurations.

DAC Cable (PN 392-05622) Connection

The DAC cable included is a 4m 5-pin Eurofast® cable with a circular connector that connects to the *DAC Outputs* connector on the control box front panel. There is a wiring diagram on the inside of the control box that shows wire connections (it can also be found in Appendix B). Connect the Ground wire (black) to the negative input on your datalogging device, and the DAC1 (brown) or DAC2 (blue) wire to the positive input on your device.

There is also a Ready Out wire (gray) that goes high when the LI-7500 has finished its warm-up period. This can be connected to a digital input on your logging device to indicate when the LI-7500 is sending "good" data.

Installing the PC Communications Software on Your Computer



The **LI7500** software is shipped on CD. It requires your computer to have an RS-232 serial (COM) interface, and Windows® 95/98/2000/NT/XP.

Insert the CD into your CD-ROM drive. If installation does not automatically start, select **Run** from the Windows *Start* menu, and select the `Setup.exe` file on the CD. When the software has finished the installation procedure, the **LI7500** program icon will be placed in the Programs menu.

NOTE: To remove the software, go to the Control Panel and select *Add/Remove Programs*. Choose LI7500 from the list of programs and click the Add/Remove button.

Operation - Using the **LI7500** Software

Data from the LI-7500 can be transferred to a computer for analysis, printing or storage using the RS-232 interface. The LI-7500 RS-232 port is configured as Data Terminal Equipment (DTE) with no hardware handshaking, and is bi-directional, meaning information can be transferred both into and out of the LI-7500.

The **LI7500** PC Communication Software that comes with the LI-7500 is used to transfer data and setup files between the analyzer and the PC.

Connect Page - Establishing Communications

The Connect page is the area in which you select the communication parameters for connecting the LI-7500 to your computer. The serial (COM) port, baud rate, and data acquisition frequency (in Hz) are chosen in this page. Click on the **Connect** button to establish communications with the LI-7500. Click on **Disconnect** to terminate communications.

It usually takes about 5 seconds before the connection is established. If something is wrong, it will time out after about 15 seconds. If this happens, make sure you've got the correct COM port, and retry.

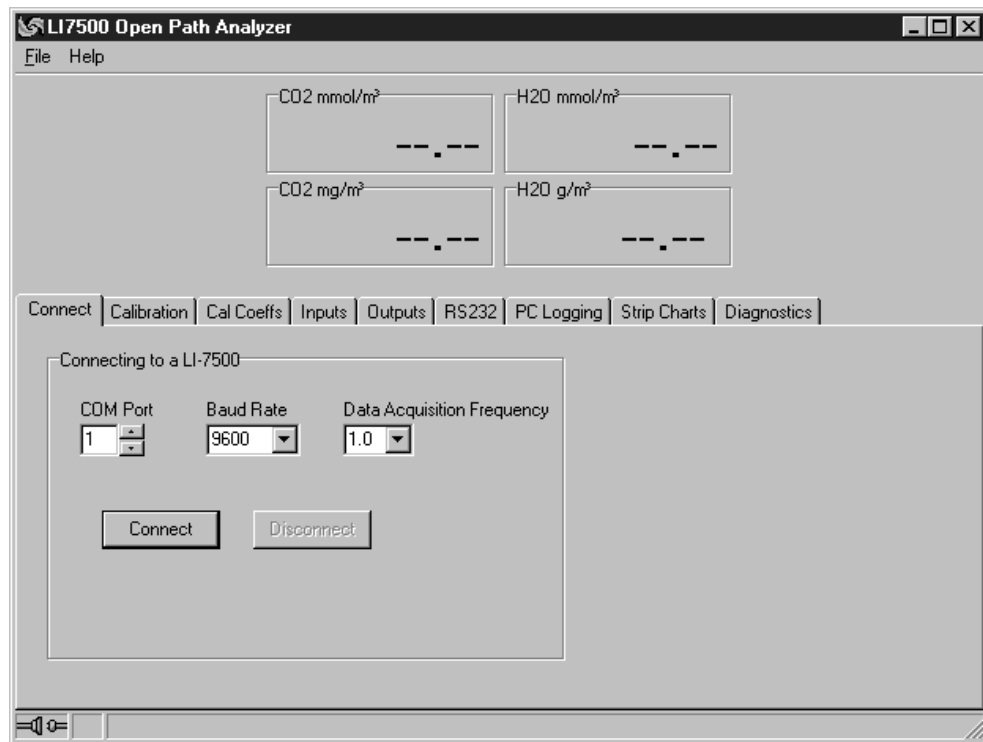

COM Port

Use the arrow buttons to select the serial port on your computer to which the LI-7500 RS-232 cable is connected. Valid numbers are between 1 and 38.

Baud Rate

Use the Baud Rate pull-down menu to select the baud rate at which to communicate with the LI-7500 through the LI-7500 serial port. The rate of data transfer is also dependent upon the maximum rate available with your computer's serial port, and the update frequency (see Data Acquisition Frequency below) to be used while the program communicates with the LI-7500. Select from 9600, 19200, or 38400.

Data Acquisition Frequency

This is the update frequency to be used while the *LI7500* program communicates with the LI-7500. Select from 1, 2, 5, 10, or 20 Hz, or enter your own value (≥ 0 and ≤ 20.0). Note that at 9600 baud, the maximum update frequency is 5 Hz; at 19200 baud, 10 Hz; and at 38400 baud, 20 Hz.

Calibration Page - Setting the Zero and Span

The Calibration page allows you to view current values of CO₂, H₂O, pressure, and temperature in real time for the purpose of calibrating the analyzer. Complete instructions for calibrating the LI-7500 can be found in Section 4.

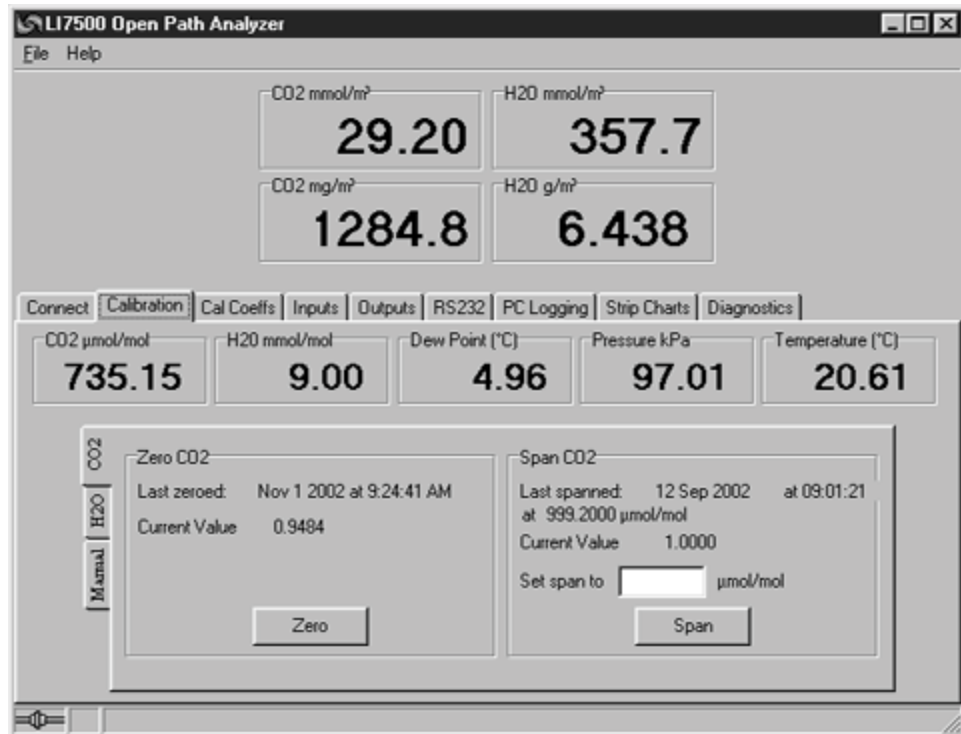

The CO₂ Page shows the time and date of the last zero and/or span calibration, and contains buttons to set the zero and span. There is also an entry field to set the target value for the span gas that is being used to set the span of the instrument.

The H₂O Page is identical to the CO₂ page, with the exception that the target value for the H₂O span is given in degrees C dewpoint.

The *Current Value* for zero is typically between 0.85 and 1.1 for CO₂ (Z_{CO_2} , see Equation 2-16) and between 0.65 and 0.85 for H₂O (Z_{H_2O} , see Equation 2-12). It is recommended that you track these values over time as you re-zero the instrument. As the internal chemicals lose their effectiveness, the values will increase. Also, the CO₂ current value will become somewhat temperature dependent.

The *Current Value* for span (CO₂ and H₂O) should be close to 1.0 (0.9 to 1.1).

The Manual Page (below) accesses an area where you can manually enter zero and span calibration values (Z_{CO_2} , S_C , Z_{H_2O} , S_W). This can be useful, for example, when manually entering values from the factory calibration sheet. Under normal operating conditions, these values typically do *not* need to be modified.

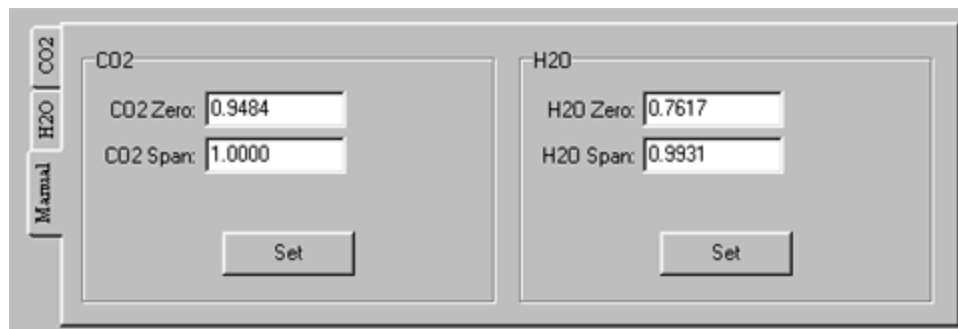

Cal Coefficients Page

The LI-7500 uses a fifth order polynomial for the CO₂ calibration, and a third order polynomial for H₂O calibration. The Calibration Coefficients page displays these factory-determined calibration coefficients, as well as a factor for correcting CO₂ measurements for band broadening due to the presence of water vapor, and a zero drift correction factor (Z). The coefficient shown as XS (Cross Sensitivity) compensates for slight cross sensitivity between CO₂ and H₂O signals absorbed by the detector (see Cross Sensitivity on page 2-4, and Zero Drift on page 2-5).

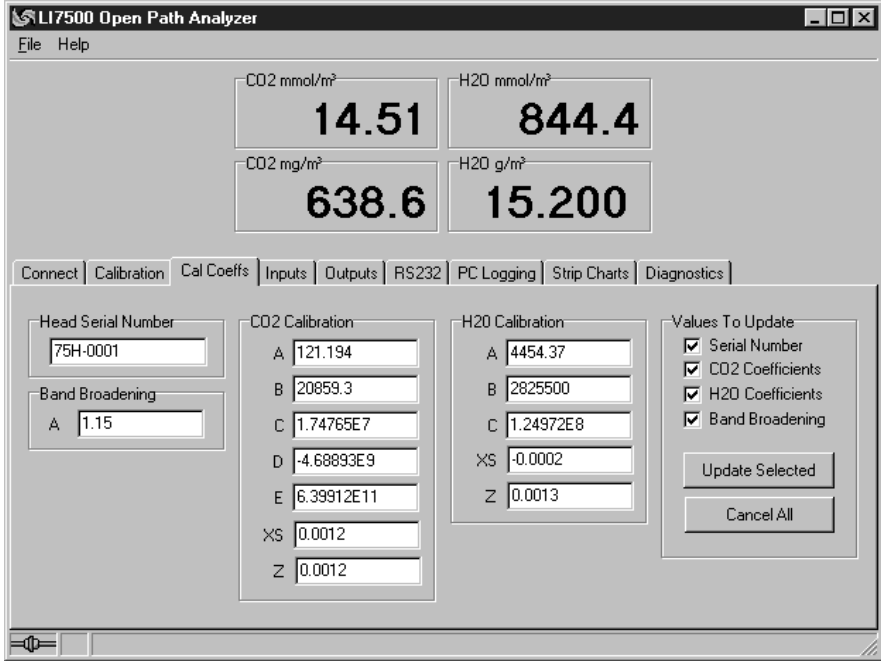

The calibration coefficients, XS, and Z values are unique to each sensor head, and may be found on the calibration sheet shipped from the factory. The Band Broadening coefficient is 1.15 for all sensor heads.

The calibration coefficients are stored in the LI-7500 control box. To change these values, edit them and then click the check boxes under *Values to Update*. Click on the *Update Selected* button to send these values to the LI-7500 for implementation. Click the **Cancel All** button to change any edited values in the window back to the state they were in before editing.

The *Head Serial Number* displays the serial number of the LI-7500 sensor head that is associated with the coefficients.

When exchanging sensor heads, it is necessary to change calibration coefficients, and to redo the zero and span.

HINT: The easiest way to get the calibration coefficients, zero, and span updated for a sensor head is to make use of the “Save Configuration” and “Open Configuration” (see *File Menu* starting on page 3-38).

Changing Sensor Heads

Sensor heads are freely interchangeable between control boxes. However, the control box must have the correct calibration coefficients, and current zero and span information, for the sensor head attached to it. This can be done by hand, or "automatically".

By Hand

1. Attach the new sensor head.
2. Connect to the computer and establish communications.
3. Enter the calibration coefficients on the Cal Coeffs page.
4. Zero and span the IRGA.

Automatic

Before removing a calibrated analyzer from its control box, use the "Save Configuration As" entry in the File menu to store the configuration information in a file. Then, to move this head to another control box:

1. Attach the sensor head to the control box.
2. Connect to the computer, and establish communications.
3. Go to the File menu and select "Open Configuration".
4. Make sure "Calibration", "Cal Coeffs", and "Update LI-7500" are checked in the "Select" dialog, and click "Continue".

Section 3

NOTE: In 2002, the design of the main circuit board was changed to accommodate temperature operations to $-40\text{ }^{\circ}\text{C}$ (instrument control box serial numbers 75B-0370 and higher). The new board revision can be identified by a green LED visible during operation (below). When moving calibration information from one control box to another (with different board revisions), the IRGA must be zeroed and spanned (Section 4). Instrument sensor heads used with main boards of the same revision typically do not require recalibration. However, it is always recommended that the IRGA zero and span be verified on the control box to be used in the field.

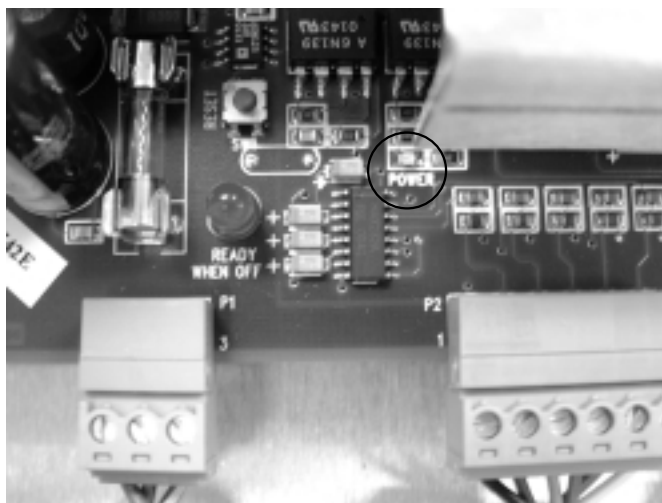

Inputs Page - Temperature, Pressure, and Auxiliary Inputs

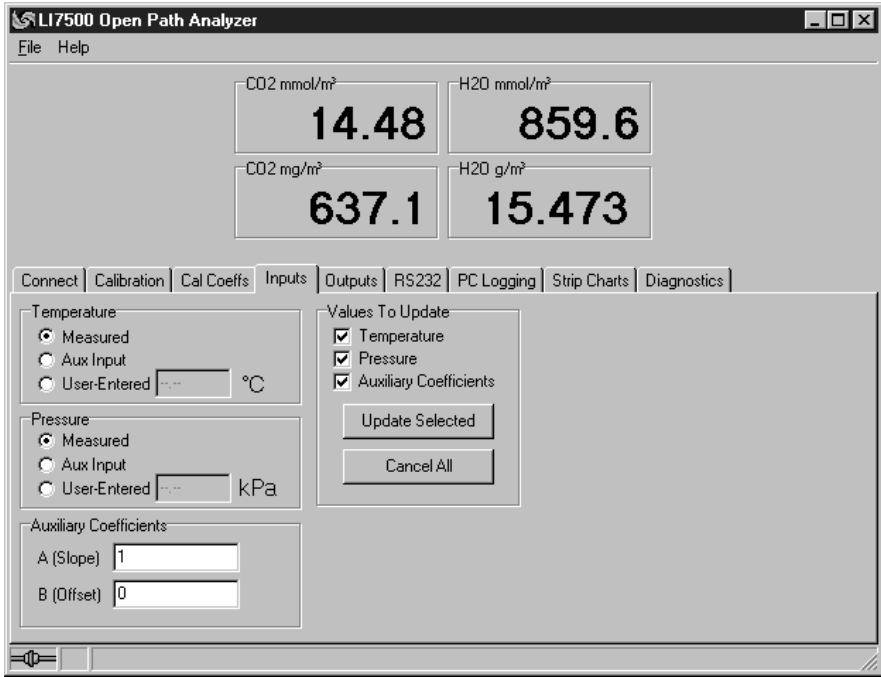

Temperature and pressure values are required by this program for converting CO₂ and H₂O density to mole fraction. In addition, the LI-7500 needs a pressure value to compute CO₂ or H₂O mole density, and a temperature value to do the band broadening correction for H₂O on CO₂.

The Inputs window allows you to specify where the temperature and pressure values are obtained; they can be measured with the on-board sensors, via a custom sensor measured at the Aux Input port, or hand-entered.

For temperature or pressure measured via the auxiliary input, there are two fields that allow you to enter values for the multiplier (A) and offset (B). Linearized voltage inputs use an equation of the form

$$Y = AV + B$$

where Y is the sensor output, V is the voltage output of the sensor, B is the Y-axis intercept (offset), and A is the calibration multiplier, which is the slope of the line representing the sensor's response (Figure 3-3).

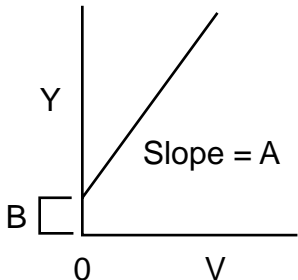

Figure 3-3. Response curve for external pressure or temperature sensors.

Use the temperature and pressure radio buttons to select the method for measuring these values. If you are using the auxiliary input, enter the values for the multiplier (A) and offset (B). If you have updated user-entered values, you need to send them to the LI-7500 for implementation using the **Update Selected** button. Click on **Cancel All** to restore any edited values in this page to their original state.

Using Auxiliary Inputs

The LI-7500 has two auxiliary input channels that can be used to attach either an external temperature or pressure sensor. Only one active *external* sensor can be attached and active at a time. The **LI7500** software (Inputs Tab) assumes selection of either the internal on-board sensors, selection of one externally measured sensor in combination with one on-board sensor or manually entered values of temperature and or pressure with one of these other options.

The **LI7500** program is used to enter slope and offset data for auxiliary sensors, via the Inputs Tab described above. The software will only accept auxiliary coefficients for one external sensor at a time. Depending on the measurements that you are taking, you will need to decide which external sensor (if any) you want to use. As emphasized before, the temperature and pressure sensors do not need to be very accurate for output of density data (e.g. mmol m^{-3}). Concentration data (e.g. ppm), however, requires much more accurate measurement of temperature and pressure. The LI-7500 does not allow output of concentration in your data stream. However, the Calibration Tab will allow you to view concentration data based on your Input Tab selections. To calculate concentration from density data would require post-processing using the equations found in Table 2-21.

The LI-7500 auxiliary input is a 12-bit differential input. The input range is 0 to +4096 mV. Since the input is uni-polar (e.g. measures only positive signals) users should note the polarity of their sensor output signal when connecting to this input channel. The physical connections from a customer supplied sensor to the LI-7500 auxiliary input would consist of using the Analog Input Cable (Part# 392-05621, in the spares kit). Appendix B details the differential input connections.

<u>Auxiliary Input Cable</u>	<u>Color</u>	<u>Customer Sensor</u>
Ground	Black	Shield
Differential In (+)	Red	Positive Signal (e.g. 0 to +5V)
Differential In (-)	Brown	Sensor Reference or Signal Ground (e.g. 0V)

This cable can be soldered onto the output leads of a customer provided sensor. The remaining conductors (Blue, Gray and White) for the auxiliary input are not used in this mode.

Why can't I use the internal thermistor *externally*?

If a user is interested in improving the temperature readings by measuring near the optical path, the internal thermistor could be removed from the auxiliary input screw terminals and soldered to the external auxiliary input cable (blue and gray wires). However, in practice, radiation loading from sunlight on this unshielded thermistor will result in significant measurement errors.

The blue and gray wires inside the enclosure are not connected to the green screw terminal block when the instrument ships from the factory. These wires will need to be connected to the Auxiliary Inputs terminal prior to using the internal thermistor externally as outlined in Appendix B.

The polynomial for the thermistor is coded in the instrument software and does not allow user to substitute another thermistor. In practice the LI-7500 does have two auxiliary inputs but only one input is available to the user for this reason.

Auxiliary Input Example:

Suppose you have a custom temperature sensor that outputs a linear 0 to +5VDC signal. This signal represents a -40 °C to +60 °C temperature range. The **LI7500** software allows you to enter the proportional multiplier (slope) and offset for this sensor. (Select the Temperature Aux Input radio button of the Inputs Tab to activate this selection).

The **LI7500** software assumes you are entering a slope in units of degrees (or kPa) per VOLT. In the example using an external temperature sensor listed above we would calculate the slope by taking the output range of the sensor divided by the proportional output voltage:

$$\frac{-40^{\circ}\text{C to } +60^{\circ}\text{C}}{0 \text{ to } +5\text{V}} = \frac{100^{\circ}\text{C Range}}{5\text{V}} = \frac{20^{\circ}\text{C}}{\text{Volt}}$$

This value (20) is then entered into the auxiliary input coefficient section. Since the output range goes below zero, a value of -40 is entered into the offset section.

The screenshot displays the 'LI7500 Open Path Analyzer' software window. At the top, there is a menu bar with 'File' and 'Help'. Below the menu bar, four large digital displays show the following values:

- CO2 mmol/m³: 29.82
- H2O mmol/m³: 557.59
- CO2 mg/m³: 1311.95
- H2O g/m³: 10.04

Below the displays is a tabbed menu with the following tabs: Connect, Calibration, Cal Coeffs, **Inputs**, Outputs, RS232, PC Logging, Strip Charts, and Diagnostics. The 'Inputs' tab is active, showing configuration options for Temperature, Pressure, and Auxiliary Coefficients.

Temperature

- Measured
- Aux Input
- User-Entered [] °C

Pressure

- Measured
- Aux Input
- User-Entered [] kPa

Auxiliary Coefficients

- A (Slope): [20]
- B (Offset): [-40]

Values To Update

- Temperature
- Pressure
- Auxiliary Coefficients

Buttons: Update Selected, Cancel All

Notes about on-board temperature and pressure sensors

The LI-7500 internal temperature sensor has an accuracy of ± 0.2 °C over a range from 0-70 °C. However, since it is positioned inside the control box the sensor will experience artificial heating from various active electronic components on the circuit board. Since the box is sealed it will also experience natural radiation loading from sunlight which will also heat up the internal temperature of the box during daylight hours. The net result is that the internal thermistor is perpetually exposed to a temperature that is higher than the actual ambient air.

The LI-7500 internal absolute pressure sensor has a range of 15-115 kPa. Its accuracy (between temperatures of 0-85 °C) is $\pm 1.5\%$ full scale span. The enclosure includes a pressure port so the internal pressure will be representative of ambient conditions.

As emphasized before the temperature and pressure sensors do not need to be very accurate for output of density data.

Outputs Page - Setting DAC and SDM Outputs

The Outputs page allows you to configure the DAC output channels, as well as configure the instrument for SDM (Synchronous Device for Measurement) output, for use with Campbell Scientific Inc. (Logan, UT) dataloggers.

The screenshot displays the LI7500 Open Path Analyzer software interface. At the top, the title bar reads "LI7500 Open Path Analyzer" with standard window controls. Below the title bar is a menu bar with "File" and "Help".

The main display area shows four large digital readouts (DROs) for gas concentrations:

- CO2 mmol/m³: 29.67
- H2O mmol/m³: 544.6
- CO2 mg/m³: 1305.4
- H2O g/m³: 9.803

Below the DROs is a tabbed interface with the following tabs: Connect, Calibration, Cal Coeffs, Inputs, **Outputs**, RS232, PC Logging, Strip Charts, and Diagnostics. The "Outputs" tab is currently selected.

The "Outputs" configuration panel contains the following sections:

- D/A Converter #1:** Source: CO2 mmol/m³; 0 V = 0.00; 5 V = 100.00
- D/A Converter #2:** Source: H2O mmol/m³; 0 V = 0.00; 5 V = 1000.00
- Delay Time (ms):** Interval: 2; DAC: $240.25 + (2 * 6.5) = 253$ ms; SDM/RS232: $186.75 + (2 * 6.5) = 200$ ms
- Bandwidth:** Radio buttons for 5 Hz, 10 Hz, and 20 Hz (selected).
- SDM Address:** 7
- Values To Update:** A list of checkboxes for Dac1, Dac2, Delay, Bandwidth, and SDM Address, all of which are checked. Below this list are "Update Selected" and "Cancel All" buttons.

At the bottom left of the window, there is a small icon representing a gas sensor or probe.

DAC Configuration

Each DAC is configured by specifying the source channel (e.g. CO₂ mmol/m³) that drives the analog signal, the source channel value which corresponds to zero volts, and the source channel value which corresponds to full scale voltage (5V).

For example, to configure DAC #1 to output a voltage signal proportional to CO₂ mmol/m³, 20 mmol/m³ full scale, select CO₂ mmol/m³ under DAC1 'Source', and set 0V = 0, and 5V = 20.

$$\begin{aligned} 0V &\rightarrow 0 && (X_o, \text{ zero volts corresponds to } 0 \text{ mmol/m}^3) \\ 5V &\rightarrow 20 && (X_F, \text{ full scale corresponds to } 20 \text{ mmol/m}^3) \end{aligned}$$

When a voltage range R is selected, the DAC output voltage V resulting from a CO₂ molar value X is given by

$$V = R \frac{X - X_o}{X_F - X_o}$$

where R = 5V.

Delay Time

The output signal from the LI-7500 optical bench is sampled by a high-speed A/D converter and input into a Digital Signal Processor (DSP). This signal is processed digitally and gas densities are computed from it. There is a fixed delay in this process, and an additional user-

programmable delay that can be used to make the LI-7500 output occur on even sampling intervals.

NOTE: The delay time applies to *all* LI-7500 outputs (SDM, DACs, and RS-232).

The LI-7500 has a fixed throughput delay of 240 milliseconds for the DAC output, and 186 ms for the SDM and RS-232 output. This delay can be increased in increments of 1/152 seconds (6.5 ms), to minimize offsets between the LI-7500 and other sensors.

For example, suppose you are sampling the LI-7500 with a Campbell Scientific CR23X datalogger at 10 Hz (0.1 s). Setting the delay count of the LI-7500 to 17 yields a total delay of .297 seconds, which means the LI-7500 data will have a delay of 3 execution intervals (0.297 s/0.1 s), which the logger can allow for in synchronizing the data to the sonic anemometer or other analog measurements made by the datalogger. Thus, the “unaccounted for” lag will be 0.003 seconds. Without this extra delay, the lag time would be .186 seconds, which is 1 execution interval (0.1 seconds) plus .086 seconds unaccounted for. A 0.086 second offset between the sonic anemometer and the IRGA can reduce the apparent flux in some circumstances.

Similarly, if you are sampling the LI-7500 with the DAC outputs, setting the delay count to 9 yields a total delay of .299 seconds. The lag will be 0.001 seconds.

Total System Delay Examples

$$\text{Total System Delay (ms)} = \text{Delay Time} + (\text{Delay Step} \times \text{Delay Step Increment})$$

Software Release	Delay Time (ms)	Delay Step (ms)	Delay Step Increment	Total Delay (ms)
DAC (3.0.0)	240	6.5	9	299
SDM, RS-232 (3.0.0)	186	6.5	17	297

Bandwidth

Bandwidth (5, 10 or 20 Hz) determines the signal averaging done by the digital filter. To avoid aliasing (only a concern for co-spectra, not for fluxes), one should sample the LI-7500 at a frequency greater than or equal to 2 times the bandwidth. Thus, if you are sampling at 10 Hz, set Bandwidth to 5 Hz.

NOTE: Bandwidth applies to *all* LI-7500 outputs (SDM, DACs, and RS-232).

Bandwidth is the frequency at which the indicated amplitude is 0.707 of the real amplitude (Figure 3-4).

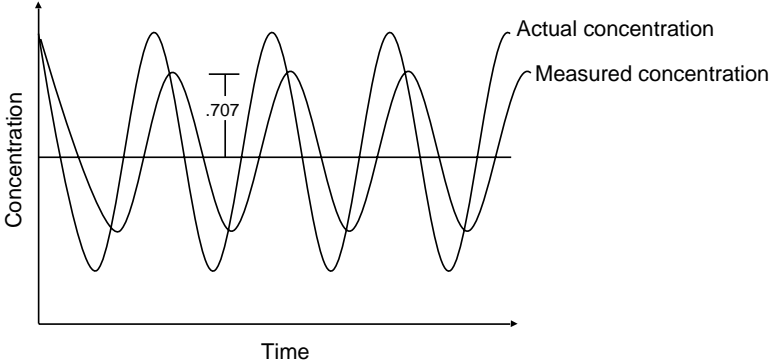

Figure 3-4. $\text{Bandwidth} = 1/\text{oscillation period}$.

Bandwidth is a useful indicator for characterizing real-world behavior in which there are fluctuating gas concentrations. Given a sinusoidal oscillation of concentration, the instrument's ability to measure the full oscillation amplitude diminishes as the oscillation frequency increases.

Note About System Delay vs. Bandwidth

The bandwidth selection has *no* impact on the system delay. The filters were designed so they have exactly the same delay whether a 5, 10, or 20 Hz signal bandwidth is selected.

SDM Address

SDM communications are enabled in Campbell Scientific dataloggers with the SDM-LI7500 instruction (Instruction 189, see the datalogger or the LI-7500 manual published by Campbell Scientific). Parameter 3 in the SDM-LI7500 instruction defines what data are sent to the datalogger from the LI-7500. Parameter 3 can take on values between 0 and 6. See Table 3-1 for parameter 3 value definitions.

Table 3-1. Parameter 3 value definitions.

Mode	Items Sent
0	CO ₂ mmol/m ³ H ₂ O mmol/m ³
1	CO ₂ absorptance H ₂ O absorptance
2	Pressure (kPa) Temperature (C) Aux channel (user units) Cooler signal (Volts)
3	Diagnostic value (see below) Bandwidth (Hz) Delay interval

Mode	Items Sent
4	CO ₂ mmol/m ³ H ₂ O mmol/m ³ CO ₂ absorptance H ₂ O absorptance Pressure (kPa) Temperature (C) Aux channel (user units) Cooler signal (Volts) Diagnostic value (see below) Bandwidth (Hz) Delay interval
5	CO ₂ mmol/m ³ H ₂ O mmol/m ³ Pressure (kPa)
6	CO ₂ mmol/m ³ H ₂ O mmol/m ³ Pressure (kPa) Diagnostic Value (see page 3-33)

Section 3

The cell diagnostic value is a 1 byte unsigned integer (value between 0 and 255) with the following bit map:

bit 7	bit 6	bit 5	bit 4	bit 3	bit 2	bit 1	bit 0
Chopper	Detector	PLL	Sync	<-----AGC / 6.25 ----->			
1=ok	1=ok	1=ok	1=ok				

Example: a value is 125 (01111101) indicates Chopper not ok, and AGC = 81% (1101 is 13, times 6.25)

Any of the parameters on this page that are edited can be sent to the LI-7500 for implementation by selecting the appropriate check boxes under 'Values to Update', and then clicking the **Update Selected** button.

RS-232 Page - Setting RS-232 Output for Unattended Logging

If you intend to use the LI-7500's RS-232 port for unattended data collection *after* the **LI7500** program is closed, you will need to configure the RS-232 output parameters in this window *before* terminating the **LI7500** program. Once configured, when you choose **Disconnect** in the Connect window, the LI-7500 will immediately begin to send data out the RS-232 port according to these parameters.

When the '*Configure RS232 Port of LI-7500 when disconnected from the PC*' check box is selected, the fields on this page become active. The parameters selected under Output will be sent to the RS-232 port at the baud rate and frequency selected. Select Ndx to output an index value. The index value is incremented every 6.5 milliseconds (e.g. 152 Hz) and ranges from approximately $-2.0E8$ to $+2.0E8$.

Use the 'Baud Rate' pull-down menu to select from 9600, 19200, or 38400 baud.

Use the 'Frequency' pull-down menu to select from 0, 1, 2, 3, 5, 10, or 20 Hz. Note that you can also type a frequency that does not appear in this list; the instrument range checks the value, and will force it to be ≥ 0.0 and ≤ 20.0 . Note too, that at 9600 baud, the maximum output frequency is 5 Hz, if outputting all 10 data items.

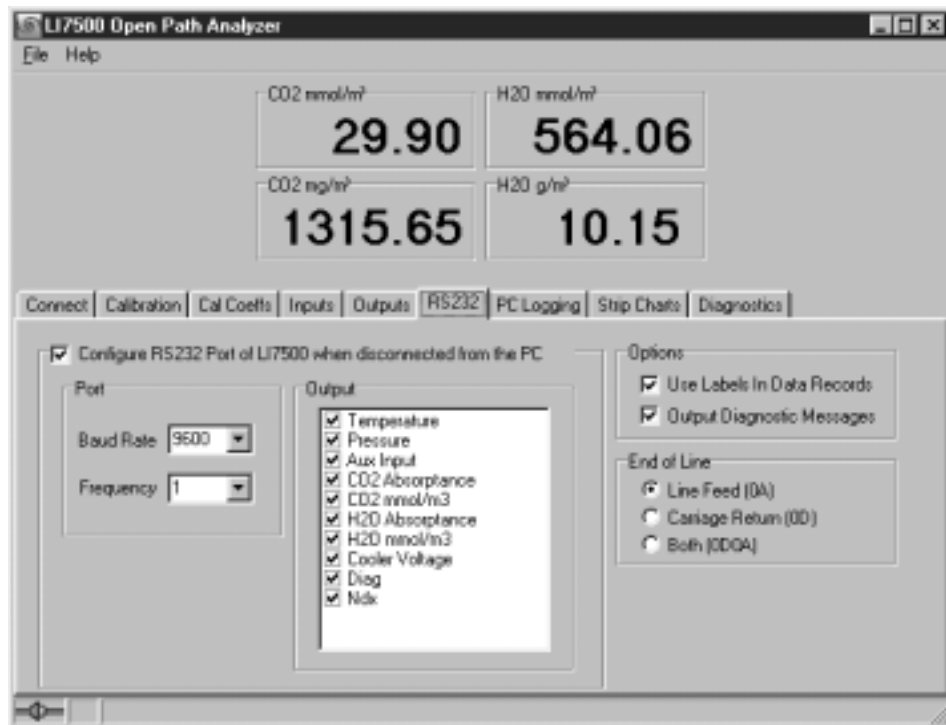

If you do not intend to use unattended RS-232 data output, simply leave the *Configure RS232 Port of LI-7500 when disconnected from the PC* check box unchecked.

Under Options, you can choose whether or not to output labels with each data record, and whether to output diagnostic text records. An example of a data record sent with and without labels is shown below.

Data format with labels:

```
(Data (Ndx 1545)(DiagVal 250)(CO2Raw 1.5386712e-1)(CO2D  
3.2183277e1)(H2ORaw 3.5775542e-2)(H2OD 1.9687008e2)(Temp  
2.4227569e1)(Pres 9.8640356e1)(Aux 0)(Cooler 1.5756724))
```

Data format without labels:

```
252 250 0.15387 32.1833 0.03578 196.870 24.22 98.6 0 1.5757
```

The End of Line buttons determine the character(s) that terminate the data records. Depending upon your recording device, a line feed, carriage return, or both may be required to properly parse the data records.

The PC Logging page (below) is used to collect data while the *LI7500* program is running.

PC Logging Page - Choosing the Values to Log

The PC Logging Page is used to configure the data output parameters used while the *LI7500* program is active. On this page you specify the destination file, information to appear in the file header, the type of delimiter to be used between data records, and the values to be logged.

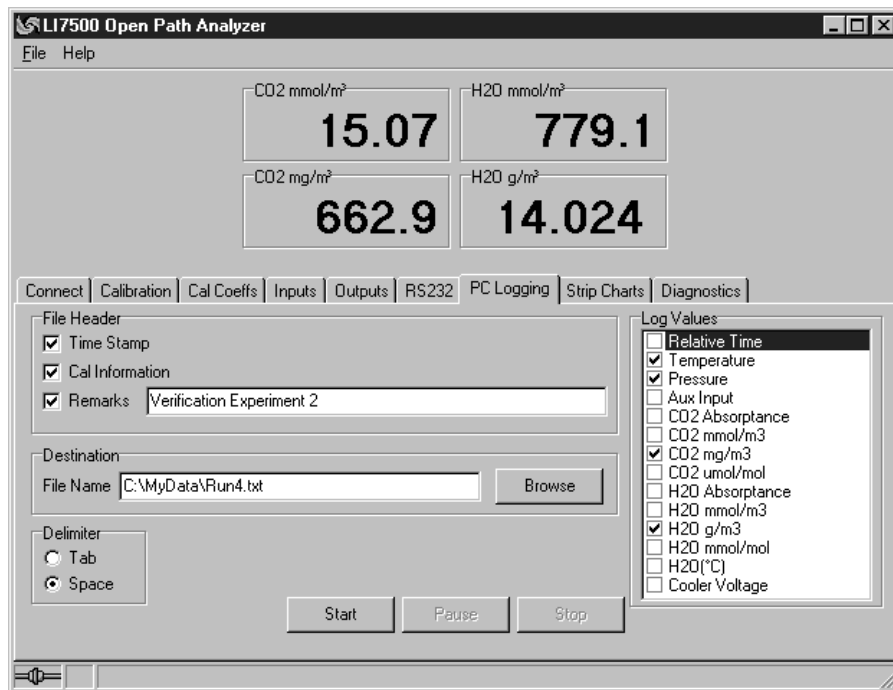

File Header

The file header is output each time the **Start** button is pressed and can contain a time stamp (derived from the computer's system time), calibration zero and span values, and user-entered remarks.

Destination

Enter a file name for the output file; the extension .TXT will be added automatically (although no extension is required). Click on the Browse button to change drives and/or directories.

Delimiter

Data can be output using tab- or space-delimited text.

Log Values

Click on the 'Log Values' check boxes to choose the variables to be output. 'Relative Time' is seconds since the **Start** button was pressed.

Strip Charts Page - Viewing Data Output

The Strip Chart page allows real time graphics display of one or two variables plotted against time. The Y-Axes (left and right) display the value chosen in the respective pull-down menus against time on the X-Axis. Choose the value in the pull-down menu, and enter values for the Y-Axis maximum and minimum. Choose the X-Axis maximum value, and select the seconds or minutes button. The scrolling buttons determine the rate of refresh of the strip chart;

smooth scrolling refreshes the chart after each data point is added (after data run off the right edge of the chart), and coarse scrolling moves the chart approximately 1/2 page at a time.

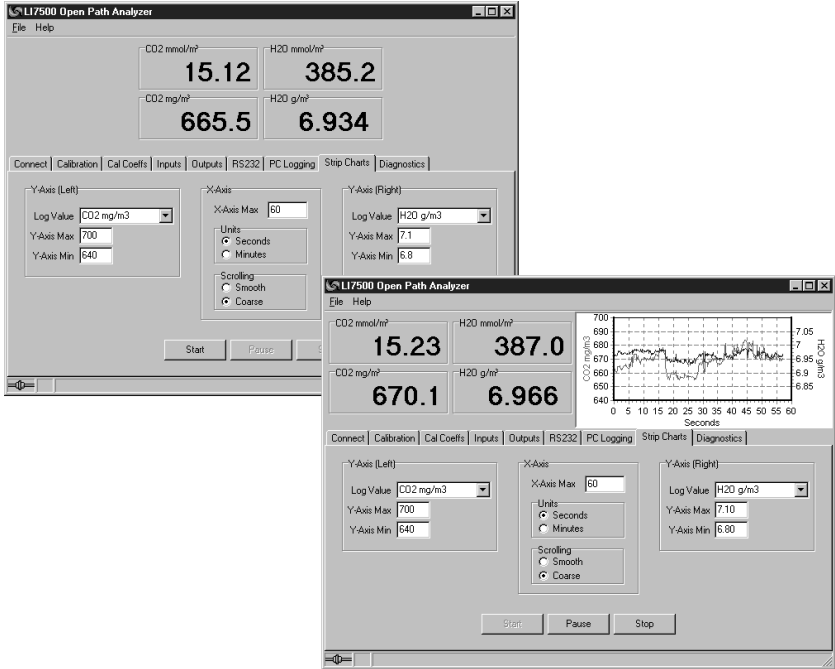

When you have configured the strip chart parameters, press the **Start** button. The chart will appear at the top of the page. Press **Pause** to temporarily stop plotting; press **Stop** to quit plotting. To update any of the strip chart parameters you must first press **Stop**. After making changes, press **Start** again.

The physical size of the strip chart will follow the window size, so for a bigger chart, enlarge or maximize the program's window.

TIP: You can rescale both Y axes of an active strip chart “on the fly”. Here's how:

To change Max and Min together, a fixed amount: right click the mouse button on the chart, hold, and drag up or down.

To change Max and Min differentially: left click the mouse button on the chart, hold, and drag to the top left (increase) or bottom right (decrease).

Diagnostics Page

The Diagnostics page allows you to view the current operational state of the LI-7500, including values of CO₂ and H₂O absorptance, optical bench properties, and the current analyzer configuration. See Section 6, *Troubleshooting* for more information about the diagnostic indicators.



'Current Configuration' parameters

This window provides an alternative method of viewing (but not setting) the LI-7500 configuration status.

Menu Description

File Menu

The File menu contains commands that allow you to open and save existing configuration files, and to exit the program.

When you choose *Open Configuration*, the Open dialog appears (below), where you can search for existing LI-7500 configuration files (denoted by a .L75 file extension).

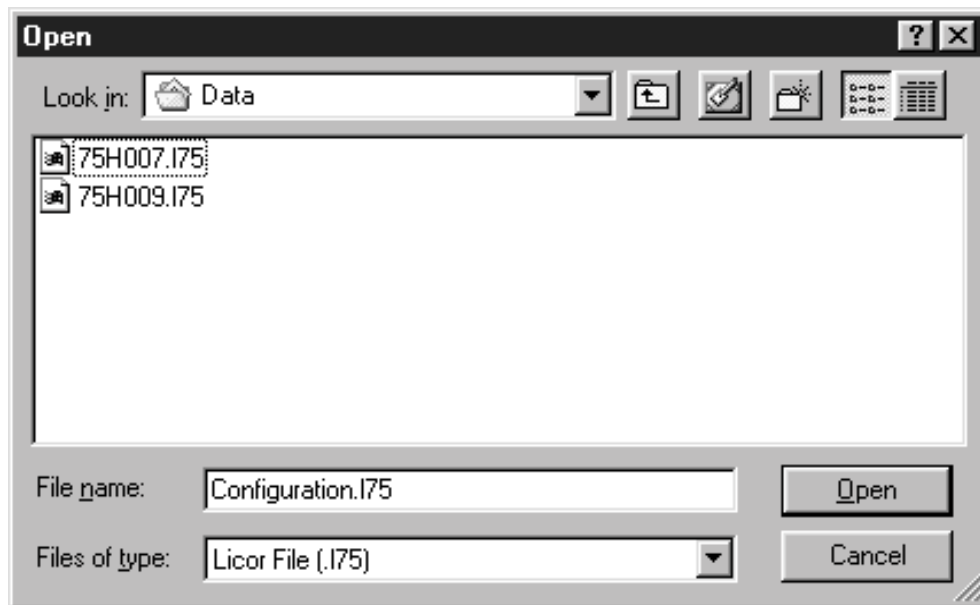

After you have selected a configuration file and clicked **Open**, the Select dialog appears (below).

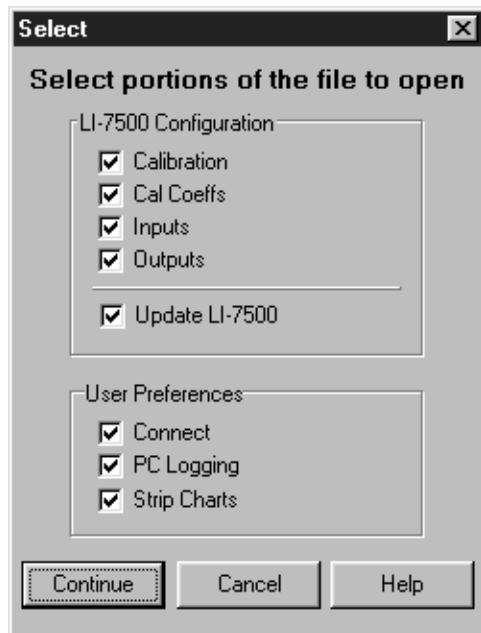

This dialog allows you to select only certain portions of the configuration file to be opened (useful if you don't want to overwrite some of your present settings in the LI-7500 software). For example, to select only the strip chart portion of a configuration file, check the 'Strip Charts' box only.

Some of the configuration items pertain to the *LI7500* PC program only, while others are part of the LI-7500 instrument configuration. This latter group is:

- Cal Coeffs
- Zero and Span
- Inputs
- Outputs and RS-232

If any of the above items are checked, you can use the “Update LI-7500” check box to have these items sent to the LI-7500 as well.

NOTE: If you leave “Update LI-7500” unchecked, the selected configuration items will still show up on the PC program’s windows, from where you can update the LI-7500 if you choose.

Example: To view the calibration coefficients found in a configuration file without changing those currently in use in the instrument, follow these steps:

1. Open the Configuration file.
2. Check only the 'Cal Coeffs' check box.
3. Clear the “Update LI-7500” check box.
4. Click **Continue**.
5. Go to the “Cal Coeffs” tab, and view them.

To “get back” the current calibration coefficients in the instrument, go to the Connect page and click **Disconnect**, then reconnect.

Similarly, selecting *Save Configuration As* opens a dialog where you can save the current configuration file with a different name.

Help Menu

About displays a screen showing the current version number of the **LI7500** software. *Help Topics* opens the LI-7500 Help file, where you can select from a list of help topics.

Operational Considerations

Dew

The LI-7500 can tolerate droplets on the windows to a certain extent; the AGC value will increase, but the calibration is unchanged. If the droplets coalesce and get big enough, the AGC will go to 100%, and eventually the readings will become bad. This can be minimized by sensor orientation, and by coating the windows with a wax such as RainX®.

Rain/Snow

Flying droplets and flakes in the optical path will affect the performance of the LI-7500, even if the total light blockage is small enough that the AGC does not reach 100%. The reason is that the objects are moving, and if a droplet or flake is in the path for a sample measurement, but out of the path for a reference measurement (or vice versa), it will influence the resulting reading. Figure 3-4 illustrates a strip chart trace made during a light snow shower. The occasional spikes are due to blockage changes between sample and reference readings. Notice that in some cases both CO₂ and H₂O are affected, and sometimes just one. Also, the spikes are equally likely to be up or down.

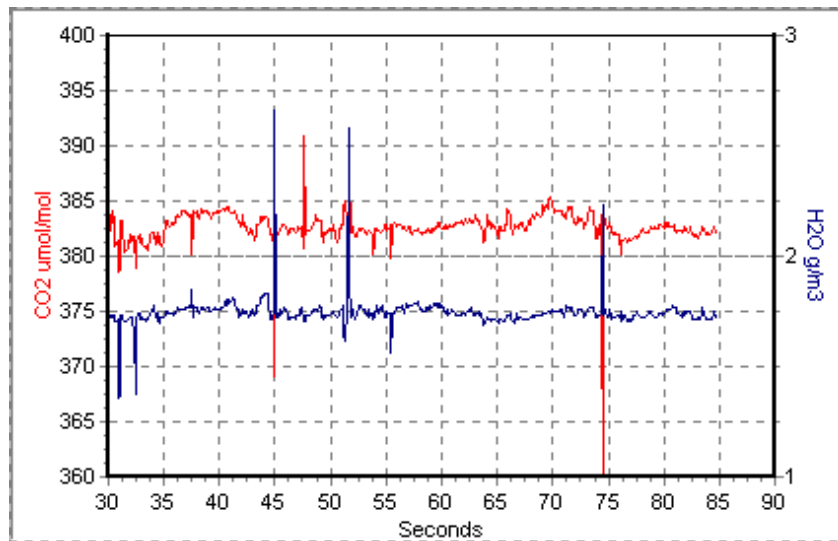

Figure 3-4. Typical strip chart trace taken during a light snow shower.

The higher the bandwidth, the more pronounced this effect, since less averaging is done.

Dust and Pollen

The LI-7500 is quite tolerant of small particulates on the windows, as long as they are small, and spectrally neutral. Pollen is a problem because it is sticky and can accumulate, so monitor the AGC values and clean the windows as needed.

Vibrations

The LI-7500 is vibration sensitive to frequencies of $152 \text{ Hz} \pm$ the bandwidth. Thus, if the bandwidth is 10Hz, the frequency problem range is 142 to 162 Hz (and upper harmonics). The instrument is completely insensitive to vibrations slower than this, and very slightly sensitive at frequencies higher than this.

For land-based installations, probably the most likely source of vibrational problems would be on a tower with tight guy wires. For other settings (aircraft, ships, etc.) where there may be vibrations in the problem range, you should try to minimize the problem through alternative mounting attachments.



Calibration

Introduction

The LI-7500's measurement accuracy depends upon its calibration. There are two major components to the calibration: 1) determining the values of calibration coefficients, and 2) setting zero and span. During a factory calibration, both of these steps are performed. The values of the coefficients that are determined should be valid for several years. The zero and span adjustments are used to bring the LI-7500's actual response into line with its previously determined factory response, at least at two points. It is the user's responsibility to do this step at regular intervals (weekly or monthly).

How Stable are Zero and Span?

The analyzer's zero is primarily affected by temperature, and the state of the internal chemicals. The internal chemicals should be changed annually (see Section 5, *Maintenance*). The zero's response to temperature is relatively small (typically 0.1 or 0.2 ppm per °C for CO₂, or 0.01 mmol/mol/°C for H₂O). Also, this drift is measured at the factory, and subsequently compensated for in software (Equation 2-10), so the effective zero drift should be quite small. Therefore, the zero should be quite stable over a several month period, but you might want to check it after an extreme temperature change (>30 °C).

The analyzer's span is affected by temperature, pressure, and the state of the internal chemicals. **Temperature:** A 10 °C change will typically change the H₂O span by 1 to 2%. For CO₂ at ambient concentrations, the span is very *insensitive* to temperature, however. **Pressure:** A large pressure change (40 kPa) will affect the CO₂ and H₂O spans by <1%, for ambient CO₂ concentrations (≈ 400 ppm) and high humidities (20 mmol/mol). So, diurnal pressure variations should not be a concern. **Chemicals:** Reduced internal chemical effectiveness will affect the span, but the effect on the zero will be much more pronounced. In summary, span stability is mostly a concern with H₂O, when there are large temperature changes.

Checking the Zero - Considerations

The zero is checked with dry CO₂-free air within the optical path of the analyzer. A suitable source of air for setting the zero can be generated with chemical scrubbers (such as soda lime for removing CO₂ and magnesium perchlorate or Drierite® for removing water), or obtained from a cylinder of zero grade gas. When using chemical scrubbers, it is important to make sure that the chemicals are fresh, and that air goes through the chemicals in the right order; soda lime first, desiccant last (if the desiccant is Drierite®, allow time for the CO₂ to "wash out" of it). When using a cylinder, it is important to make sure that the air in the cylinder really is CO₂-free since a typical cylinder of standard grade nitrogen might have as much as 20 ppm of CO₂ in it. Compressed cylinders may be at pressures of several thousand pounds per square inch; before using them for calibration, they should be fitted with a regulator to reduce the pressure down to a range of around thirty pounds per square inch.

Checking the Span - Considerations

For checking the CO₂ span, use a cylinder of CO₂ in air with a concentration that is at the higher end of the range of concentrations which may be encountered during measurements. For example, a 500 to 1000 PPM cylinder of CO₂ in air, which has been verified to be accurate to within at least 1% would be a suitable choice for many applications. Be cautious, as the stated value of the calibration cylinder may be significantly different from the actual gas concentration.

For the water vapor span, a convenient standard to use is a dew point generator such as the LI-COR LI-610. To avoid condensation problems choose a dew point temperature that is about 3 to 5 °C below the ambient temperature. Also, since water vapor sorbs and desorbs from surfaces, allow plenty of time for the reading to stabilize. It is important not to rush through the water vapor calibration. If it is more convenient, CO₂ and water vapor zero and span calibrations can be done separately. *In general, if reliable calibration standards are not available or if there is not enough time to do the job properly, it is better to leave the zero and span settings alone than to rush through the procedure and make incorrect settings.*

What Actually Happens

In the LI-7500, the zero and span parameters are set in software via the serial port using a personal computer (see Section 3). What actually happens when the zero is set is that the value of Z_{CO} (or Z_{WO} for water) is determined. For example, when CO₂-free air is in the optical path of the analyzer, α_c should be 0. From Equation 2-16,

$$\alpha_c = 0 = \left(1 - \left[\frac{A_c}{A_{CO}} + X_{wc} \frac{A_w}{A_{WO}} \right] (Z_{CO} + Z_c V_d) \right)$$

so

$$Z_{co} = \frac{1}{\frac{A_c}{A_{co}} + X_{wc} \frac{A_w}{A_{wo}}} - Z_c V_d \quad 4-1$$

Similarly,

$$Z_{wo} = \frac{1}{\frac{A_w}{A_{wo}} + X_{cw} \frac{A_c}{A_{co}}} - Z_w V_d \quad 4-2$$

When the span is set, the value of S_c (or S_w for water) is determined. For example, if there is a known CO_2 density ρ'_c in the optical path, then from Equation 2-17,

$$\rho_c = \rho'_c = P_{ec} f_c \left(\frac{\alpha_c}{P_{ec}} S_c \right)$$

so

$$S_c = \frac{f_c^{-1} \left(\frac{\rho'_c}{P_{ec}} \right) P_{ec}}{\alpha_c} \quad 4-3$$

ρ_c is given by 2-16.

In terms of a known mole fraction m'_c , instead of a known density,

$$S_c = \frac{f_c^{-1} \left(\frac{m'_c P}{P_{ec} RT} \right) P_{ec}}{\alpha_c} \quad 4-4$$

If the CO₂ concentration is dry, then $P_{ec} = P$, so

$$S_c = f_c^{-1} \left(\frac{m'_c}{RT} \right) \frac{P}{\alpha_c} \quad 4-5$$

Similarly,

$$S_w = \frac{f_w^{-1} \left(\frac{m'_w}{RT} \right) P}{\alpha_w} \quad 4-6$$

α_w is given by 2-12.

Complete Step-by-Step Calibration Instructions

1. Run the program (see Section 3). Then select the *Calibration* tab in the Main Window of the 7500-50 Communications software.
2. Place the calibration tube into the sensor head as shown in Figure 4-1 and connect the temperature sensor cable to the LI-7500 control box.

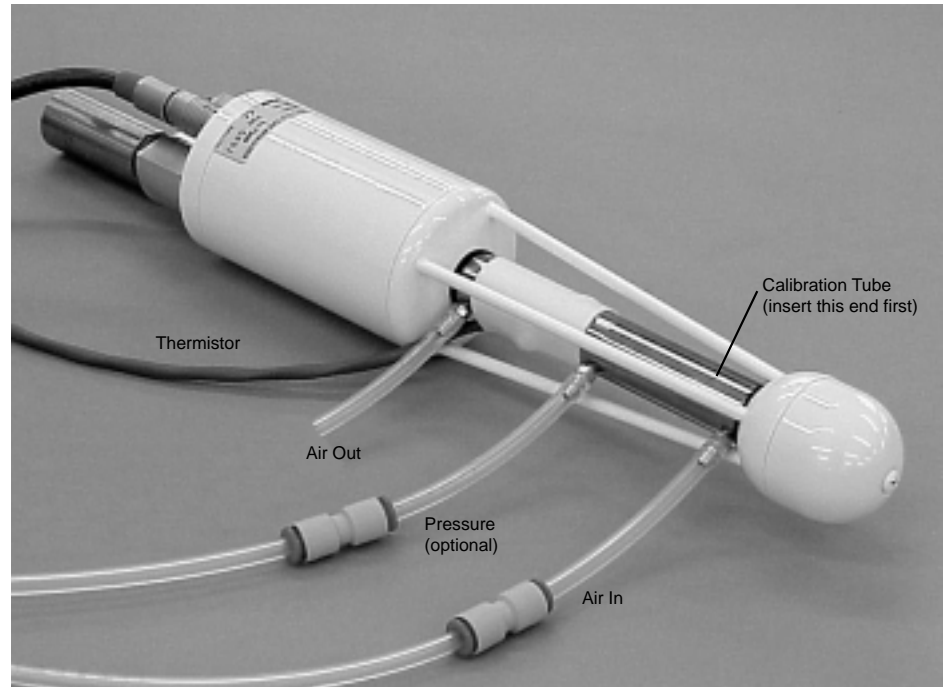

Figure 4-1. Flow calibration gas at the Air In port shown.

Insert the top of the fixture first, and slide the bottom into place. It is very important that the fixture is centered between the windows covering the source and detector modules. It can be helpful to click on the *Diagnostics* tab in the 7500-50 software, and view the AGC value while centering the fixture; if the AGC value increases when the fixture is in place, it indicates that one or both of the windows are partially or totally obscured. Move the fixture back and forth until the AGC value reads the same value as before the fixture was inserted. The fixture is very easy to center; if it looks centered, it probably is.

NOTE: The three ports are entirely interchangeable.

3. Click on the *Calibration* tab, and verify that temperature and pressure are working OK. (If you are using an alternate source for temperature and pressure, click on the *Inputs* tab and set that up).

IMPORTANT NOTE: Always zero the instrument before spanning (don't span, then zero).

4. Flow CO₂-free air through the calibration fixture at a rate of about 0.5 to 1.0 LPM. Attach the zero gas to the calibration fixture at one of the ports shown in Figure 4-1.

Zero CO₂

5. Observe the CO₂ concentration and wait for it to stabilize (typically 1 minute). Also, note the present value of Z_{CO} (Figure 4-2).

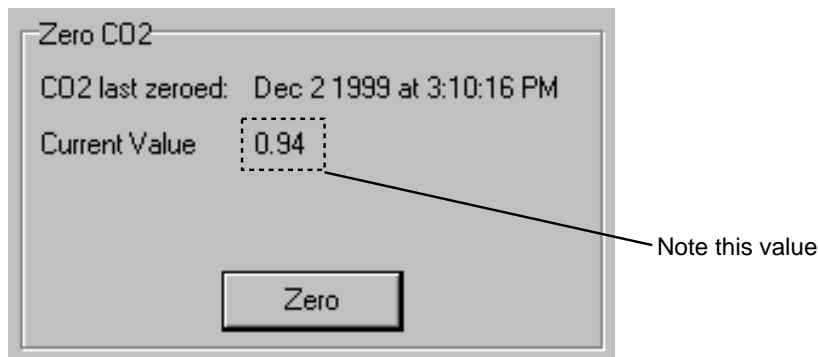

Figure 4-2. Note value of Z_{CO_2} , shown as Current Value.

6. When the reading has stabilized, click **Zero** to set the CO₂ zero. After a brief delay, the displayed CO₂ value should be fluctuating around zero. Check the resultant value of Z_{CO_2} shown on the *Zero CO₂* page (Figure 4-2). It should be near 1 (typically between 0.85 and 1.1). This value will steadily increase as the internal chemicals lose effectiveness.

Zero H₂O

7. Now is a good time to check or set the H₂O zero, if you have been flowing dry, CO₂-free air through the optical path. Click the H₂O tab, and note the present value of Z_{H_2O} .
8. Wait for the H₂O reading to stabilize (3 or 4 minutes).

9. Click **Zero**. Note the new value of Z_{wo} (typically between 0.65 and 0.85).

Span CO₂

10. Flow a CO₂ span gas through the calibration tube at 0.5 to 1 liter/minute.
11. Click on the *CO₂ Cal* tab. Enter the mole fraction in the target entry.
12. When stable (1-2 minutes) click **Span**. Check the value of S_c (typically 0.9-1.1).

Span H₂O

13. To set the H₂O span, flow air of known dew point through the calibration tube at about 0.5 to 1.0 LPM. To avoid condensation, use a dew point temperature several degrees below the ambient temperature.
14. Click the H₂O tab, and note the present value of S_w . Enter the span gas dew point temperature in the target entry.
15. Observe the H₂O dew point and wait for it to stabilize. This may take up to 15 or 20 minutes.
16. When the reading has stabilized, click **Span**. Note the value of S_w (typically 0.9-1.1).



Maintenance

Cleaning the Optical Path

The LI-7500 optical windows should be cleaned when necessary (when the AGC value approaches 100%). If the windows become dirty it may become difficult to calibrate the analyzer. Excessive zero drift may also be observed if the optical path becomes obstructed.

The windows are sapphire, and are extremely durable and resistant to scratches; clean the windows with any mild detergent or glass cleaner. Also, coating the windows with a water resistant windshield type coating (such as Rain-X®) or a high quality automobile type wax may help prevent droplets from remaining on the windows during rainstorms. Mounting the sensor head at a slight angle from vertical (~10-15°) may also help prevent water droplets from remaining on the windows during rainstorms.

Section 5

The LI-7500 sensor head shown below in Figure 5-1 is from a long term test on a roof top on a snowy day (January 2001) in Lincoln, NE. Note the small puddle of water on the sapphire window; the AGC value was at 100%.

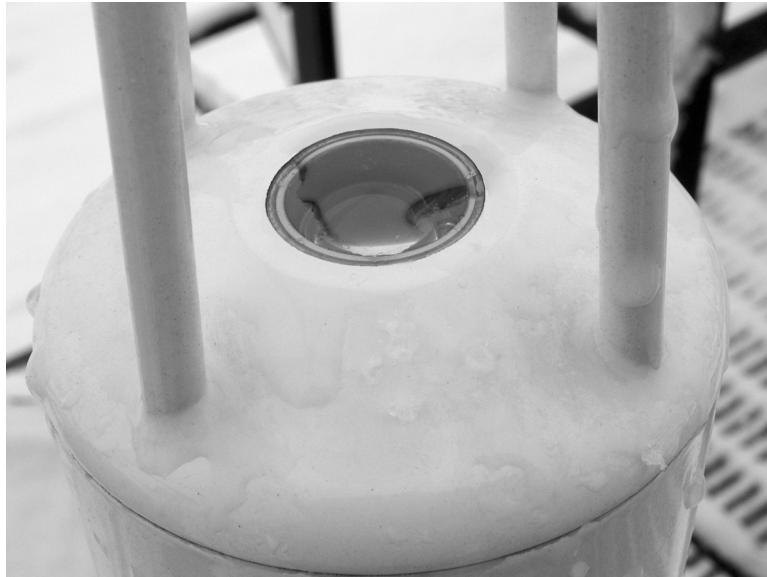

Figure 5-1. Water on the sapphire windows can cause AGC values at or near 100%.

Changing the Fuse

The LI-7500 power supply is protected by a 5A 250V, 5 × 20 mm fast-blow type fuse located on the main circuit board inside the control unit case (Figure 5-2). If the battery or other power source fails to power the LI-7500, check to see if the fuse has blown.

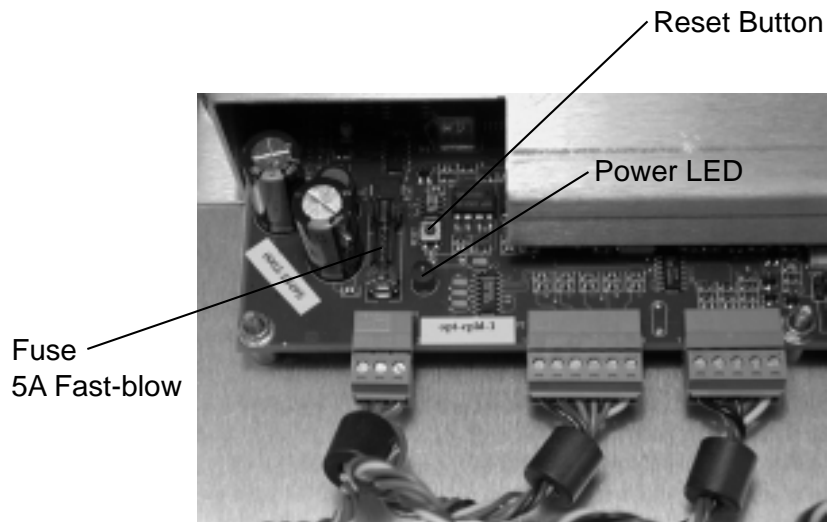

Figure 5-2. LI-7500 fuse location.

To check the fuse, power the unit off, disconnect the power to the unit, and open the case of the LI-7500 control unit. The fuse is located on the main circuit board, in the lower lefthand corner, as shown in Figure 5-2. Replacement fuses (part #439-04214, in the spares kit) plug into the fuse holder; no soldering is required. Replace the fuse and close the LI-7500 case.

Replacing the Internal Chemicals

There are two small plastic bottles, each containing Ascarite II and magnesium perchlorate, inserted into the analyzer housing that keep the detectors free of CO₂ and water vapor. These bottles should be recharged with fresh chemicals on an annual basis. Replacement "charged" bottles are available from LI-COR in sets of two under part number 7500-950. If you want to recharge the bottles yourself, see *Appendix C, Suppliers*, for a list of suppliers of Ascarite II and magnesium perchlorate.

NOTE: Calibration shifts will occur if CO₂ or H₂O are not kept out of the analyzer housing.

■ **To change the sensor head soda lime/desiccant bottles:**

1. The plastic bottles are located in the analyzer housing in the sensor head. They are accessed by removing the mounting bracket from the analyzer housing (Figure 5-3). Remove the two screws on the bottom of the mount; be careful not to lose the spacers and washers.

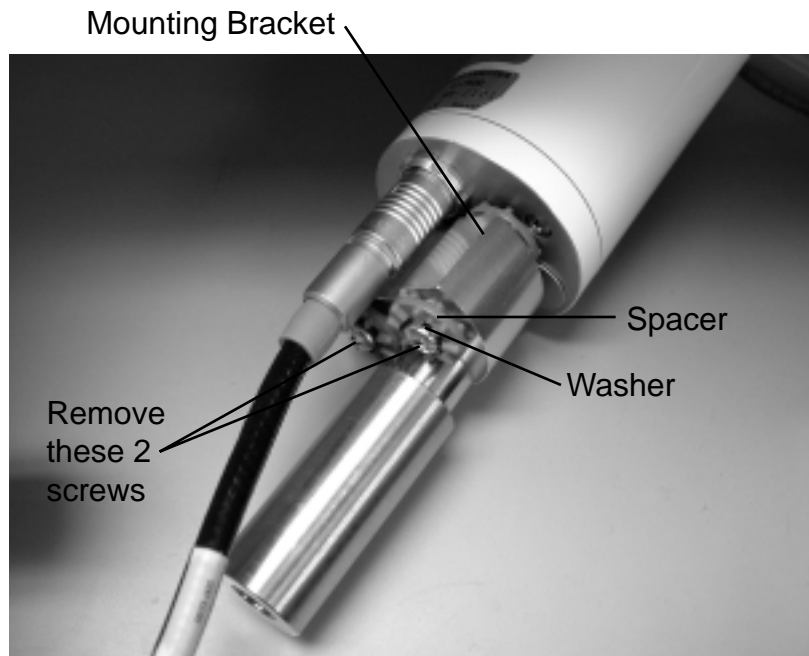

Figure 5-3. Remove the 2 screws on the base of the mounting bracket.

Section 5

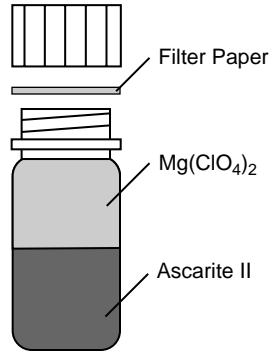

Figure 5-4. Fill the bottles with Ascarite II, followed by magnesium perchlorate.

2. Before removing the bottles, prepare the new bottles (in spares kit) by filling them with equal parts Ascarite II and magnesium perchlorate (Figure 5-4). Fill the bottles half full with Ascarite II first, followed by the magnesium perchlorate. Place a filter paper disk in the lid to keep the chemicals from spilling into the detector housing.
3. There are two bottle covers, each with an O-ring seal, at the base of the sensor head (Figure 5-5). Remove the cover retention screw. Thread a 6/32" screw (there is one 2 inches long in the spares kit) into each cover and pull straight out.

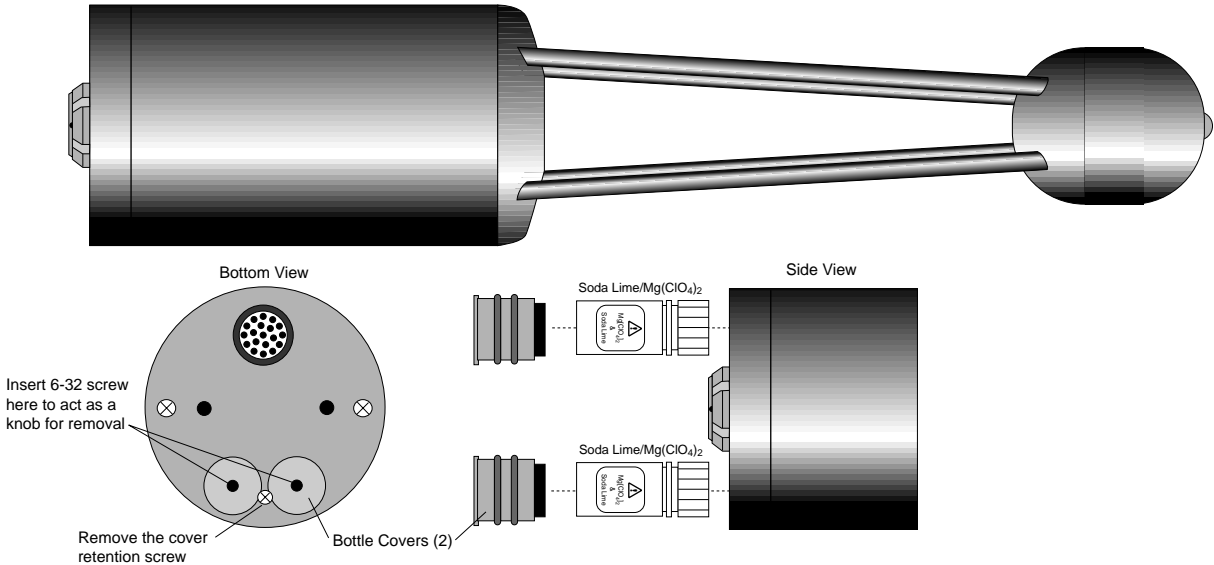
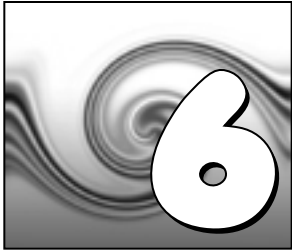

Figure 5-5. Remove the screw holding the bottle covers and replace the chemicals.

- 4. Insert the recharged bottles into the analyzer housing *cap first*. Replace the bottle covers and the cover retention screw and reattach the mounting bracket.

5. After installing, ***allow at least 4 hours*** (preferably with the instrument powered on) to scrub the housing. This should be followed by setting the CO₂ and H₂O zeros. Check the zero again, if possible, after one or two days.

NOTE: LI-COR has written a publication that describes the use of chemical scrubbing agents with LI-COR gas analyzers. This publication, entitled "*Using CO₂ and H₂O Scrubbers with LI-COR Gas Analyzers*" is available free of charge from LI-COR. Ask for publication #IRG4-101.



Troubleshooting

Power On Problems

The instrument requires between 10 and 30 VDC, at 2 Amps, to operate (a LI-COR LI-6020 battery charger, for example, will *not* by itself power the LI-7500). When adequate power is first applied to the instrument, the LED in the box near the fuse (Fig 5-1) will light up for about 5 seconds, then (if operating correctly) go off and remain off. If any of the diagnostics listed below become true during the operation of the instrument, then the LED will come back on.

NOTE: On instrument serial numbers 75B-0370 and above, a red LED is used as the status indicator, which should turn off after 5-10 seconds. A second green LED should stay lit when the LI-7500 is powered on.

LED does not light at power on

This can be due to a blown fuse, or inadequate power supply, or faulty wiring (make sure the black wire on the power cable goes to ground, and the red wire to power).

PC Connection Problems

When the Connect button in the *LI7500* Windows program is pressed, the program sets a break condition on the communication line, signaling the LI-7500 to change to 9600 baud and send its current configuration. The PC then sends the desired configuration (update rate, baud rate, etc.) back to the LI-7500. Both units then change to the desired baud rate, and operations begin. When the Disconnect button is pressed, the PC signals to LI-7500 to change its RS-232 configuration back to what it was originally (or to that set up in the RS-232 panel).

"Port in use or does not exist" when connecting

This message indicates that the COM port setting on the Connect page is either incorrect, or else that COM port is already in use by some other program running on the PC. If you are sure that the COM port is correct, and there is nothing else running, try rebooting.

"Not able to connect to the LI-7500 successfully" when connecting

Press Connect again. Sometimes it takes a couple of attempts. If repeated attempts fail, then make sure the COM port is in fact the one into which you are connected. Review Figure 3-3, and make sure you are connected according to one of the methods indicated there. Make sure the LI-7500 is in fact powered and running (press the Reset button (Fig. 5-2) and see if the LED lights for about 5 seconds).

Bad Temperature or Pressure Readings

The source of the values of temperature and pressure displayed on the Calibration page are determined by the setting on the Inputs page. If the source is "Measured", the readings come from the LI-7500's on-board sensors (or the thermistor on the calibration tube, if that is connected). If the source is "Aux Input", then the temperature or pressure (but not both) are coming from an external sensor that you have wired and connected. This signal is modified according to the Auxiliary Coefficients that appear on that same page. If the source is "User-Entered", then whatever you enter in the text boxes is used for the value.

Temperature is Measured, and reads -65 (or so)

The thermistor is broken, or disconnected. Check the 6 pin connector on right of the board to make sure it is plugged in, and to make sure the thermistor wires are both attached to the connector at pins 4 and 5.

Pressure is Measured, and doesn't match my barometer

The pressure sensor in the LI-7500 is good to about 1%. For operating purposes, it doesn't need to be very good (See "Note on Temperature and Pressure" on page 2-12). When setting the span of the LI-7500, however, it is important. If you know the pressure better than the LI-7500 does, then use the "User-Entered" option and enter it.

Bad CO₂ or H₂O Readings

Section 2 details what the LI-7500 measures, and how it computes. Most of the relevant parameters are available for viewing with the **LI7500** program, such as calibration coefficients, absorptances, and zero and span values. The first thing to check when tracking down bad readings is to make sure all of the coefficients on the "Cal Coeffs" page match those on the calibration sheet for the head in use. The Band Broadening coefficient should be 1.15. After that, go to the "Diagnostics" page and check the values of AGC, and also the CO₂ and H₂O absorptances. Are any of the diagnostics flags (PLL, etc.) set? Finally, go to the "Calibration" page and make sure the temperature and pressure make sense, and that the current values of zero and span are near 1.

Absorptances make sense, densities don't

If the absorptance value displayed on the Diagnostics page seem correct (*rough* rule of thumb: absorptance = 0 when density = 0, CO₂ absorptance is about 0.1 with a mole fraction of about 400 ppm, and H₂O absorptance is about 0.1 with a mole fraction of about 20 mmol/mol), but if the displayed values of density or mole fraction are obviously bad, then the problem is in one of the following: calibration coefficients, span parameter, pressure value, and the band broadening value (CO₂ only).

Readings very noisy

Put the calibration tube in place, just to dampen natural fluctuations. You don't necessarily need to have anything flowing through the tube. The noise in absorptance values ("Diagnostics" page, below) should be stable, with only the 4th decimal place changing once

in a while. If density or mole fraction is still noisy, watch the temperature and pressure values to see if they are the source of the noise (or change to a hand entered, constant value to try this). Check the calibration coefficients and band broadening value (if the problem is with CO₂) to make sure they are correct.

Diagnostic Messages

The Diagnostics page allows you to view the current operational state of the LI-7500, including values of CO₂ and H₂O absorptance, optical bench properties, and the current analyzer configuration.

The screenshot displays the LI7500 Open Path Analyzer software interface. The main display area shows four large numerical readouts: CO2 in mmol/m³ (26.20), H2O in mmol/m³ (345.1), CO2 in mg/m³ (1152.7), and H2O in g/m³ (6.212). Below these are several tabs: Connect, Calibration, Cal Coeffs, Inputs, Outputs, RS232, PC Logging, Strip Charts, and Diagnostics. The Diagnostics tab is active, showing an Optical Bench section with a Diagnostic Value of 89 and various status indicators (PLL, Detector, Chopper, Sync Flag, Cooler Voltage, AGC) all set to OK or 0.90. An Absorbance section shows CO2 at 0.1474 and H2O at 0.0689. A Current Configuration tree on the right lists various system components like Ack, Calibrate, Cool, Data, Diagnostics, EmbeddedSW, Error, Inputs, and Outputs.

CO ₂ mmol/m ³	H ₂ O mmol/m ³
26.20	345.1

CO ₂ mg/m ³	H ₂ O g/m ³
1152.7	6.212

Connect | Calibration | Cal Coeffs | Inputs | Outputs | RS232 | PC Logging | Strip Charts | **Diagnostics**

Optical Bench
Diagnostic Value: 89
PLL: OK
Detector: OK
Chopper: OK
Sync Flag: OK
Cooler Voltage: 0.90
AGC: 70%

Absorbance
CO₂: 0.1474
H₂O: 0.0689

Current Configuration
- [x] Ack
- [x] Calibrate
- [x] Cool
- [x] Data
- [x] Diagnostics
- [x] EmbeddedSW
- [x] Error
- [x] Inputs
- [x] Outputs

'Optical Bench' indicators:

Diagnostic Value - The cell diagnostic value is a 1 byte unsigned integer (value between 0 and 255). See Section 3, *Outputs Page - Setting DAC and SDM Outputs* for a description of the integer bitmap.

PLL - Phase Lock Loop offset, indicates the status of the chopper motor. If not OK, there may be a problem with the chopper motor in the sensor head.

Detector - If not OK, indicates the detector cooler is not maintaining the proper temperature: this will happen at temperatures above 50 °C. Note that this does *not* always indicate a serious problem; the cooler may simply have not yet reached the target temperature during instrument startup, or it may be out of range due to external environmental conditions. Readings may still be OK. Check cables and wiring.

Chopper - If not OK, indicates the chopper temperature controller is out of range, hot or cold. As with the Detector indicator above, this may or may not indicate a serious problem. The chopper should be able to temperature control when ambient is between +50 and -25 °C.

Sync Flag - If not OK, indicates that the LI-7500 embedded software and the digital signal processor (DSP) receiving the signal from the chopper motor in the sensor head are out of sync. Check cabling.

Absorptance values - CO₂: computed according to Equation 2-16.

H₂O: computed according to Equation 2-12.

Cooler Voltage - Displays voltage of detector cooler. If this value gets below 0.05, it may be too cold; the detector may not be temperature controlling. This will typically be at -30 °C or below.

AGC - Note this value when you first operate the LI-7500. Typical values are 50-60%. As dirt accumulates on the sensor head windows the value of AGC will increase, so you can use this value to indicate when it is necessary to clean the windows.

LI7500 Error Messages

The following error messages may be encountered in the **LI7500** Communications Software program.

Error Message	Description
The file was opened but could not be sent to the LI-7500.	An error occurred when transmitting the file to the LI-7500. Not being connected is the most probable cause.
Please enter a positive floating point value.	None
Please enter a faster baud rate.	The baud rate selected is not fast enough to keep up with the data acquisition frequency.
Not able to connect to the LI-7500 successfully.	Initial data exchange did not occur successfully. Check to see if connections are secure.
The port you have selected, COMx, is either in use or does not exist.	The communications port is busy with another piece of hardware or does not exist on the system.
Please enter a positive integer.	None
Make sure you have at least 1 log value and have specified a filename.	In order to log data on the PC you must have a file name and have at least one value checked in the "Log Values" list box.

Section 6

Error Message	Description
A confirmation for your last action was not received. Results are questionable.	Each action or update sent to the LI-7500 requires an acknowledgement. One was not received for your last action. It is unknown if the action was successful or not.
An error occurred on the LI-7500.	Internal Error.
The configuration sent from the LI-7500 contained errors.	The configuration sent from the LI-7500 did not parse correctly. Attempt to reconnect.
Enter a valid DAC Source.	Select a DAC source from the list
Error found in configuration file! The file could not be opened.	The data in the configuration file is corrupt.
Auxiliary Input can only be selected for Temperature or Pressure.	The auxiliary input can only be selected for one item.
Select a valid Log Value for the left Y-axis.	Choose a value from the list to plot.
Select a valid Log Value for the right Y-axis.	Choose a value from the list to plot.
Please enter a floating-point number.	None

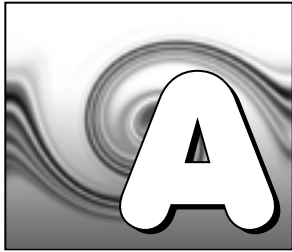

Specifications*

Type: Absolute, open-path, non-dispersive infrared gas analyzer.

Detector: Thermo-electrically cooled lead selenide.

Bandwidth: 5, 10, or 20 Hz, software selectable.

Path Length: 12.5 cm (4.72").

Operating Temperature Range: -25 to 50°C (-40 to 50 °C verification test available on request).

User Interface: Windows® based software supports all setup, configuration and calibration functions through RS-232 serial port.

Outputs: RS-232 (20 Hz Maximum)

SDM (>40Hz)

2 user scalable 16 bit DACs updated at 300 Hz.

Auxiliary Inputs: 2 channels for temperature and pressure sensors (during calibration).

Auxiliary Input with pressure sensor: 0-4.096V ($\pm 5V$ common mode rejection).

Power Requirements: 10.5 to 30 volts DC.

Power Consumption: 30 W during warm-up, 10 W in steady state.

Dimensions:

Head: Dia 6.5 cm, Length 30 cm. Designed for minimal wind flow disturbance.

Appendix A

Control Box: 35 cm × 30 cm × 15 cm (external dimensions).

IRGA cable: 3 meters (between sensor head and electronics control box).

Power, Serial, DAC, Auxiliary Input and SDM cables: 4 meters

Weight: Head: 0.75 kg (1.65 lb.), Control Box and Cables: 4.8 kg (10.5 lb.)

CO ₂		μmol mol ⁻¹	mmol m ^{-3†}	mg m ^{-3†}
Calibration range		0 - 3000	0 - 117	0 - 5148
RMS noise at ambient (370 ppm) PSD* = 35 ppb/√Hz typical 70 ppb/√Hz max.	Bandwidth: 5 Hz 10 Hz 20 Hz	0.08 0.11 0.16	0.0031 0.0043 0.0061	0.13 0.19 0.27
Zero drift with temperature (per °C)	Maximum Typical	±0.3 ±0.1	±0.012 ±0.004	±0.5 ±0.2
Gain drift with temperature at 370 ppm (% of reading per °C)	Maximum Typical		±0.1% ±0.02%	
Direct sensitivity to H ₂ O (mol CO ₂ /mol H ₂ O)	Maximum Typical		±4.00E-05 ±2.00E-05	

† at 25 °C, 98 kPa

* Power Spectral Density

H ₂ O		mmol mol ⁻¹	mmol m ^{-3†}	g m ^{-3†}
Calibration range		0 - 60	0 - 2340	0 - 42
RMS noise in moist air (10 mmol mol ⁻¹) PSD* = 1.5 ppm/√Hz typical 2.5 ppm/√Hz max.	Bandwidth: 5 Hz 10 Hz 20 Hz	0.0034 0.0047 0.0067	0.13 0.18 0.26	0.0024 0.0033 0.0047
Zero drift with temperature (per °C)	Maximum Typical	±0.05 ±0.03	±2 ±1	±0.04 ±0.02
Gain drift with temperature at 20 mmol mol ⁻¹ (% of reading per °C)	Maximum Typical		±0.3% ±0.15%	
Direct sensitivity to CO ₂ (mol H ₂ O/mol CO ₂)	Maximum Typical		±0.05 ±0.02	

* Specifications subject to change without notice.

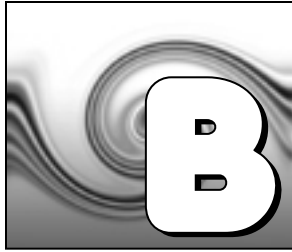

Pin Assignments

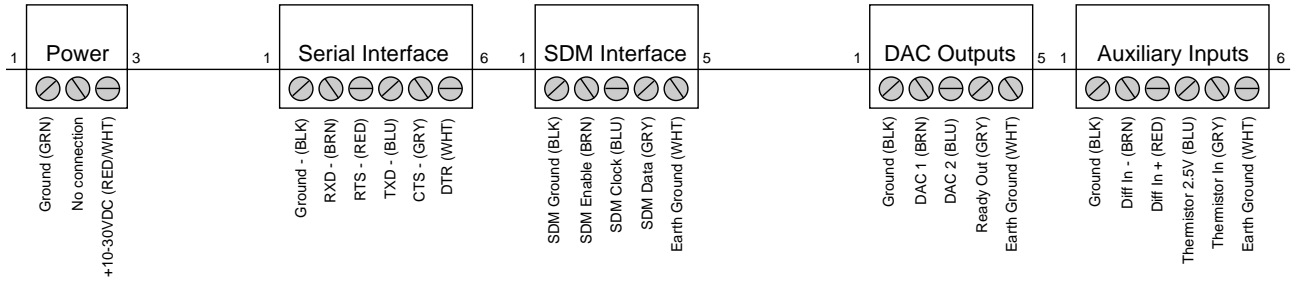

The sensor head is connected to two terminal strips at the upper righthand corner of the main circuit board, underneath the protective cover. Under normal circumstances you will not need to alter any of the sensor head connections. If, however, any of the wires should pull loose, refer to the diagram below for proper wiring connections. The protective cover can be removed by unscrewing the four screws at the corners of the cover.

Appendix B

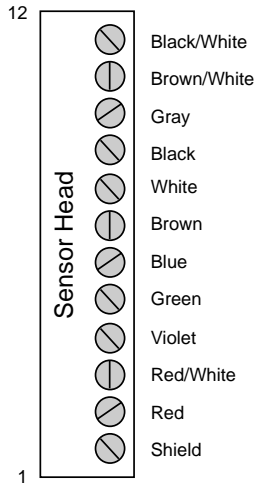



Suppliers

The company names, addresses, and phone numbers are the most current we have at the time of this printing. In some cases the information may change without notice.

Soda Lime (6-12 mesh) and Magnesium Perchlorate (Anhydrous) $Mg(ClO_4)_2$

GFS Chemicals

P.O. Box 245

Powell, OH 43065

Phone: 614-881-5501

FAX: 614-881-5989

Toll free: 800-858-9682

www.gfschemicals.com

Soda Lime: Part #66352

Appendix C

Fisher Scientific

711 Forbes Avenue
Pittsburgh, PA 15219-4785
Phone: 201-467-6400
FAX: 201-379-7415
Toll free: 800-776-7000
Toll free FAX: 800-926-1166
www.fishersci.com

Soda Lime: Part #S201-212
(LI-COR Part #9960-071)

Mg(ClO₄)₂: Part #M54-500 (500g)

Thomas Scientific

P.O. Box 99
Swedesboro, NJ 08085-6099
Phone: 609-467-2000
FAX: 609-467-3087
Toll free: 800-345-2100
Toll free FAX: 800-345-5232
www.thomassci.com

Soda Lime: Part #C703-B76

Mg(ClO₄)₂: Part #C260-M61
(Dehydrite, 500g)

Ascarite II (8-20 mesh)**Fisher Scientific**

711 Forbes Avenue
Pittsburgh, PA 15219-4785

Phone: 201-467-6400

FAX: 201-379-7415

Toll free: 800-776-7000

Toll free FAX: 800-926-1166

www.fishersci.com

MAX17731

8-20 Mesh

Thomas Scientific

P.O. Box 99

Swedesboro, NJ 08085-6099

Phone: 609-467-2000

FAX: 609-467-3087

Toll free: 800-345-2100

Toll free FAX: 800-345-5232

www.thomassci.com

C049H40

8-20 Mesh

Appendix C

Eurofast® and Microfast® Cables (see Table C-1)

Turck Inc.

3000 Campus Drive

Minneapolis, MN 55441

Phone: 612-553-7300

FAX: 612-553-0708

www.turck.com

Table C-1. Eurofast® and Microfast® cables used to connect to the LI-7500.

LI-COR Part Number	LI-7500 Control Box Connector	Cable Connector Type	Turck Part Number
392-05618	SDM Interface	5-pin female	RK 4.5T-*/S90
392-05619	Power	3-pin female	KB 3T-*/S90
392-05620	Serial Interface	6-pin female	RKC 6T-*/S90
392-05621	Auxiliary Inputs	6-pin male	RSC 6T-*/S90
392-05622	DAC Outputs	5-pin male	RS 4.5T-*/S90

* = cable length; 2, 4, or 6 meters. Other lengths available by request from Turck Inc.

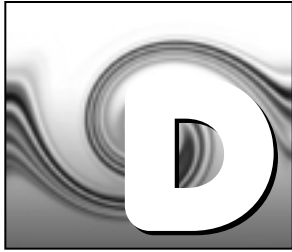

Configuration Grammar

Introduction

This section describes the protocol used by the LI-7500 to communicate via RS-232, for both configuration and data output purposes. Commands sent to the LI-7500 have a certain structure that must be followed, and data sent by the LI-7500 comes packaged in a particular way. For example, to set the Bandwidth to 10Hz, the following string

```
(Outputs(BW 10))
```

should be sent followed by a line feed character (decimal 10). Each command begins with a left parenthesis ‘(’, and ends with a right parenthesis ‘)’. Some commands, such as (BW . . .) contain a single value, while other commands, such as (Outputs . . .), can contain one or more commands. The parentheses mark the start and stop of the command, and extra

characters before or after are ignored, as well as white space (spaces and tabs) before or after the parentheses. This string would work equally as well, for example:

```
This is ignored ( Outputs (BW 10  ) ) and so is this
```

The LI-7500 does not try parsing a command string until a line feed is received. Since "extra" characters are ignored, commands can be terminated with carriage return and line feeds equally as well.

Another example of a command string is

```
(Outputs(RS232(Freq 10)(Pres TRUE))(BW 5))
```

In this case, we are setting the RS-232 output frequency to 10Hz, requesting that Pressure be included in the output records, and that the bandwidth be 5 Hz. Notice the 2 parentheses at the end of (Pres TRUE)). This is because (Pres..) and (Freq..) are (RS232..) commands, while (BW..) is not. (BW..) and (RS232..) are both (Outputs..) commands, however, and the "extra" parenthesis at the end of (BW 5)) signals the end of the (Outputs..) command.

An illegal command string would be

```
(BW 5)
```

because the (BW. . .) command is only recognized within the context of an (Outputs. . .) command.

The LI-7500 configuration grammar is case sensitive. That is, (Outputs(BW 10)) will work, while (outputs(bw 10)) will not.

Who Sends What

Not all of the commands in the LI-7500's grammar are really commands. Some are designed to be used by the LI-7500 to package outgoing data. The (Data. .) command, or record, might look like this

```
(Data (CO2D 2.2083146e1)(H2OD 3.5485935e2)(Temp 2.5886261e1)(Pres
9.8157062e1))
```

This record is showing the latest values of CO₂ and H₂O mole density (mmol m⁻³), temperature (°C), and pressure (kPa). The fields present in a (Data. .) record, and how often they are output, is determined by the (Outputs. .) command.

Once it has established communications with a host computer (discussed in the next section), the LI-7500's RS-232 communications is largely made up of outgoing (Data. .) and (Diagnostics. .) records. The only other type of records it might send are (Error. .) and (Ack. .). The (Error. .) record is sent whenever the LI-7500 receives a command it cannot

parse or recognize, and the (Ack..) record acknowledges a configuration change. It is also used to pass back the new zero or span setting after a (Calibrate..) command.

Command Summary

In the following sections, some abbreviations are used:

{int} means an integer value, such as 0, 10, 452, etc.

{float} means any integer or floating point value, such as 0, 3.14159, 1E-7, -3.47e-09, etc.

{string} means anything (< 40 characters) contained by double quotes, such as "Hey, you!"

{ item1 | item2 | item3 } means you must include one of the items in the list.

{bool} - *{ TRUE | FALSE }*

The (Outputs..) Command

(Outputs..) is used to configure the items pertaining to data output, including the bandwidth, delay time, DACs (digital to analog convertors), and the RS-232 port. The actual RS-232 output uses the (Data..) record described in Table 2.

Table 1: The Outputs Command

Command	Subcommands		Remarks	
(Outputs	(BW {5 / 10 / 20})		Sets instrument bandwidth to 5, 10, or 20 Hz.	
	(Delay {int})		Output delay interval (0 to 32), where each interval is 1/152 seconds. This is added to the 230 ms system delay.	
	(Dac1 Dac2	(Source {List ^a }))	The variable that drives the DACs (digital to analog convertors)
		(Zero {float})		Value that corresponds to 0 Volts output
		(Full {float})		Value that corresponds to 5 Volts output
	(SDM	(Address {int}))	SDM address (0 thru 14).

Appendix D

Command	Subcommands		Remarks	
(Outputs	(RS232	(Baud {9600 19200 38400 })	Baud rate for RS-232	
		(Freq {float})	Output frequency of (Data..) records in Hz. Usable values: 0.0 thru 20.0	
		(Pres {bool})	These commands determine what is included in the (Data output record	
		(Temp {bool})		
		(Aux {bool})		
		(CO2Raw {bool})		
		(CO2D {bool})		
		(H2ORaw {bool})		
		(H2OD {bool})		
		(Cooler {bool})		
		(EOL {"hex code(s)"})		User defined termination character(s) for data record in "hex" (e.g. "0D0A" would be carriage return line feed). Default is "0A" = line feed.
		(Ndx {bool})		
		(DiagRec {bool})		
		(DiagVal {bool})		
(Labels {bool})				

a. One of { CO2A | CO2MMOL | H2OA | H2OMMOL | TEMPERATURE | PRESSURE | AUX | NONE }

(EOL "{hex code(s)}")

End of Line character. Enter hex value in double quotes.

Example:

```
(Outputs(RS232(EOL "0D0A"))1f
```

would terminate data strings with a carriage return and a line feed.

(Ndx {bool})

Determines whether an index value is transmitted or not.

Example:

```
(Outputs(RS232(Ndx TRUE))1f
```

would cause the data stream to contain an index value. The index value is incremented approximately every 6.5 milliseconds (e.g. 152 Hz) and ranges from approximately -2.0E8 to +2.0E8.

(DiagRec {bool})

Controls whether independent (Diagnostic) *text* records are ever sent. If TRUE, operates normally (1/second or on a change). If FALSE, never sends a Diagnostic record.

Example:

```
Transmitted: (Outputs(RS232(DiagRec TRUE)))1f
```

```
Received: (Diagnostics (SYNC TRUE)(PLL TRUE)(DetOK TRUE)(Chopper TRUE)(Path 61))
```

(DiagVal {bool})

Controls whether or not a 1 byte diagnostic value (0-255) is output (same as SDM diagnostic value, see page 3-28) in the (Data stream. "Diag" is used for the label when (Labels TRUE is set.

Example:

Transmitted: (Outputs(RS232(DiagVal TRUE)))lf

Received: (Data... (Diag 249...))

NOTE: The (DiagRec and the (DiagVal are two separate outputs and are independent of one another.

(Labels {bool})

This command controls whether or not data labels are transmitted with the data stream. Default is TRUE, and this means that data are transmitted in the normal (Data) format record. When (Labels FALSE), however, data output are values only and are tab-delimited. To maximize available bandwidth, when (Labels FALSE), a data record might appear as

```
15.1234<tab>354.123<tab>101.3<tab>249<eol>
```

The following are several examples of data formatting. The command string sent to the LI-7500 is terminated with a line feed character.

EXAMPLE (Labels TRUE) Data format

Transmitted to LI-7500

```
(Outputs(RS232(Freq 1)(EOL "0D0A")(Ndx TRUE)(DiagRec FALSE)(DiagVal TRUE)(Labels TRUE)))lf
```

Received from LI-7500

```
(Data (Ndx 1545)(DiagVal 250)(CO2Raw 1.5386712e-1)(CO2D 3.2183277e1)(H2ORaw  
3.57  
75542e-2)(H2OD 1.9687008e2)(Temp 2.4227569e1)(Pres 9.8640356e1)(Aux  
0)(Cooler 1.5756724))  
(Data (Ndx 1809)(DiagVal 250)(CO2Raw 1.5380490e-1)(CO2D 3.2162146e1)(H2ORaw  
3.57  
57541e-2)(H2OD 1.9677452e2)(Temp 2.4227569e1)(Pres 9.8543587e1)(Aux  
0)(Cooler 1.5750400))
```

EXAMPLE (Labels FALSE) Data format

Notice how this format is much cleaner and reduces the overhead of redundant label transmissions. The data selected for output data record is accomplished with the (Outputs(RS232(CO2Raw TRUE)...))command.

Transmitted to LI-7500

```
(Outputs(RS232(Freq 1)(EOL "0D0A")(Ndx TRUE)(DiagRec FALSE)(DiagVal TRUE)(Labels FALSE)))lf
```

Received from LI-7500

252	250	0.15401	32.2167	0.03569	196.703	24.33	98.6	0	1.5730
511	250	0.15404	32.2174	0.03572	196.816	24.42	98.5	0	1.5683
765	250	0.15402	32.2342	0.03579	196.995	24.49	98.6	0	1.5703
1033	250	0.15400	32.2097	0.03571	196.771	24.63	98.5	0	1.5724
1288	250	0.15405	32.2341	0.03578	196.838	24.76	98.5	0	1.5734
1544	250	0.15406	32.2385	0.03575	196.782	24.72	98.5	0	1.5724

NOTE: There is a difference in the output data format lengths depending whether LABELS is set to TRUE or FALSE. See the two examples listed below:

Example (Labels TRUE)

Value	Example
CO2Raw	1.5388799e-1
CO2D	3.2176308e1
H2OD	1.9711704e2
Temp	2.4171295e1
Pres	9.8543587e1
Aux	0
Cooler	1.5700240

LABELS FALSE

Value	Floating Point	Example
CO2Raw, H2ORaw, Aux	x.xxxxx	0.12345
CO2D	xx.xxxx	15.1234
H2OD	xxx.xxx	354.123
Cooler	x.xxxx	1.1234
Temp	xx.xx	24.35
Press	xxx.x	101.3

Value	Integer	Example
Ndx	variable length	~ -2E8 to +2E8
Diag.	xxx	250

Examples:

1. To set the LI-7500 to output only CO₂ and H₂O molar densities once every 2 seconds:

```
(Outputs(RS232(Freq .5)(Pres FALSE)(Temp FALSE)(Aux FALSE)(CO2Raw  
FALSE)(CO2D TRUE)(H2ORaw FALSE)(H2OD TRUE)(Cooler FALSE)))
```

2. To configure DAC #1 to output CO₂ mole density with this scaling: 0V = 12 mmol m⁻³, and 5V = 15 mmol m⁻³.

```
(Outputs(Dac1(Source CO2MMOL)(Zero 12)(Full 15)))
```

Data and Status Records

The (Data..) and (Diagnostics..) records are the vehicles with which the LI-7500 outputs data through its RS-232 port. The frequency with which it outputs (Data..) records is determined by the (Outputs(RS232(Freq..))) command, shown in Table 1. Data and status record formats are determined by the (Outputs(RS232 (boolean controlled command structure. (EOL {"hex codes"})) and (Labels {boolean})) determine the termination characters and whether or not (Data labels are output.

Table 2: Data and Diagnostics Records

Record	Subcommands	Remarks	
(Data	(Ndx {int})		Index value. Boolean controlled output. Increments every 6.5 ms (1/ 152). Resets to 0 whenever the configuration changes, or (with no changes) about every 163 days.
	(Temp {float})	Temperature, °C	The values included are set by (Outputs(RS232..)). How often this is output is determined by (Outputs(Freq..)).
	(Press {float})	Pressure, kPa	
	(Aux {float})	Auxiliary input value	
	(CO2Raw {float})	CO ₂ absorptance	
	(CO2D {float})	CO ₂ density (mmol m ⁻³)	
	(H2ORaw {float})	H ₂ O absorptance	
	(H2OD {float})	H ₂ O density (mmol m ⁻³)	
	(Cooler {float})	Detector cooler (Volts)	
	(Diag {int})	Diagnostic value 0-255. Boolean controlled output.	
(Diagnostics	Boolean controlled output determined by (Outputs(RS232(DiagRec {bool}))).	If TRUE, then output at 1 Hz. If FALSE, then no (Diagnostic text record output.	

Record	Subcommands	Remarks	
(Diagnostics)	(PLL <i>{bool}</i>)	Phase lock loop status	Diagnostics are always output at 1 Hz
	(DetOK <i>{bool}</i>)	Detector temperature control	
	(Chopper <i>{bool}</i>)	Chopper temperature control	
	(Path <i>{float}</i>)	The AGC value in % (0-100)	
(Ack)	(Received TRUE)	Sent by the LI-7500 to acknowledge any incoming command.	
	(Val <i>{float}</i>)	Only sent after zeroing and spanning commands. Contains the new, computed value of zero or span.	
(Error (Received TRUE))		Sent by the LI-7500 when it cannot parse or recognize a command.	
(EmbeddedSW)	(Version <i>{quoted string}</i>)	Output by the LI-7500 during synchronization.	
	(Model <i>{quoted string}</i>)		

Examples:

1. A typical (Data..) output record, with all items present, is shown below:

```
(Data (Ndx 215713)(CO2Raw 1.2831902e-1)(CO2D 2.2083146e1)(H2ORaw  
5.5372476e-2)(H2OD 3.5485935e2)(Temp 2.5886261e1)(Pres 9.8157062e1)(Aux  
0)(Cooler 1.0537354))
```

2. A typical (Diagnostics..) record is shown below:

```
(Diagnostics (Sync TRUE)(PLL TRUE)(DetOK TRUE)(Chopper TRUE)(Path 63))
```

Data Polling (Software and Hardware)

A software command using the ENQ character (0x05) is available to query the LI-7500 for a data record. When transmitted to the LI-7500, the record is built as presently defined (Labels TRUE or FALSE, etc.), and is added to the output queue. This software command is normally used when the update frequency is set to zero, as shown in the command below.

```
(Outputs (RS232 (Freq 0)(DiagRec FALSE)))lf
```

The LI-7500 also supports toggling of the Clear To Send (CTS) line to request a data record. This hardware polling would be normally used when the update frequency is set to 0 as described above. Since the CTS line is an *input*, the host software should toggle the Request To Send (RTS) line from the host computer. This method of transmitting a data record occurs when the CTS line goes from low to high. The CTS line must be in the active (high) state for

the LI-7500 to transmit a data record. The length of time that CTS must be held low is very short (~50 microseconds).

Users familiar with programming RS232 interfaces may already understand that RS-232 logic TRUE (1) is considered a low (or negative) voltage and logic FALSE (0) is considered a high (or positive) voltage. Thus, the CTS toggle sequence would look like:

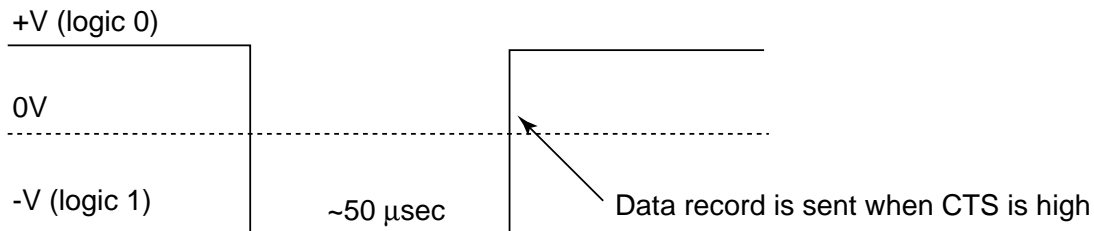

The CTS line is the gray conductor found on the LI-COR RS-232 Cable, part #392-05620. The RS-232 serial pinout from a DB9 connector on an AT style computer is defined as:

Pin	Signal Description	Function	Signal at Device
1	DCD	Data Carrier Detect	Input
2	RD	Received Data	Input
3	TD	Transmit Data	Output
4	DTR	Data Terminal Ready	Output
5	SG	Signal Ground	
6	DSR	Data Set Ready	Input
7	RTS	Request To Send	Output
8	CTS	Clear To Send	Input
9	RI	Ring Indicator	Input

A possible wiring configuration using the LI-COR RS-232 cable, part #392-05620 to a computer would be:

LI-COR CABLE

Color	Function
Black	Ground
Brown	Receive Data
Red	Request To Send
Blue	Transmit Data
Gray	Clear To Send
White	Data Terminal Ready

DB9 ON HOST COMPUTER

PIN	Function
PIN 5	Ground
PIN 3	Transmit Data
PIN 8	Clear To Send
PIN 2	Receive Data
PIN 7	Request To Send
PIN 6	Data Set Ready

Note about Embedded Software RS-232 Communication Priorities

The RS-232 hardware and software trigger does not tap directly into the same data stream that is output to the DAC's and the SDM. The trigger actually sends a request to the data router task in the DSP to output a single data record over the RS-232 port. The processing that is incurred to do this is relatively lengthy. The RS-232 task is also a low priority, so considerable latency could occur. If you want output data that is tightly synchronized to an input stimulus you should use the SDM output or sample a DAC output based on your trigger; don't use RS-232.

The (Inputs..) Command

The (Inputs..) command is used to scale the Auxiliary input channel, and to determine how pressure and temperature are measured by the LI-7500.

Table 3: The Inputs Command

Command	Subcommands			Remarks
(Inputs	(Pressure (Temperature	(Source / Aux Measured UserEntered))	How it is determined
		(Val {float})		Fixed value, for “UserEntered”
	(Aux	(A {float}))	Slope
		(B {float})		Intercept

Examples:

1. To make pressure fixed at 92 kPa, send this:

```
(Inputs(Pressure(Source UserEntered)(Val 92)))
```

2. To measure temperature from a linearized thermistor connected to the Auxiliary input, where 0 volts is 0°C, and 5 volts is 50°C, send this:

```
(Inputs(Aux(A 10)(B 0))(Temperature(Source Aux)))
```

3. To measure pressure and temperature normally, using the built-in sensors, send this:

```
(Inputs(Pressure(Source Measured))(Temperature(Source Measured)))
```

The (Calibrate..) and (Coeffs..) Commands

The (Calibrate..) and (Coeffs..) commands control zeroing, spanning, and factory calibration coefficients. The (Date subcommand must be present, and (Val must be absent to perform (ZeroH2O and (ZeroCO2. For (SpanCO2 and (SpanH2O, (Date and (TDensity must be present, and (Val must be absent to trigger a calibration.

Table 4: Calibration Commands (Continued)

Command	Subcommands			Remark
(Calibrate	(ZeroH2O (ZeroCO2	(Val <i>{float}</i>))	For setting the zero directly. If not present will trigger a calibration.
		(Date <i>{quoted string}</i>)		The date field triggers the LI-7500 to do a zero immediately. The new value will be returned in an (Ack..) record.
	(SpanCO2 (SpanH2O	(Val <i>{float}</i>))	For setting the span directly. If not present will trigger a calibration.
		(Target <i>{float}</i>)		Target value in ppm for CO ₂ , or °C for H ₂ O (for reference purposes).
		(TDensity <i>{float}</i>)		Target value in mmol m ⁻³ . (For computational purposes).
		(Date <i>{quoted string}</i>)		

Command	Subcommands				Remark
(Coeffs	(Current	(SerialNo <i>{quoted string}</i>)			The 75H-xxxx head number.
		(Band (A <i>{float}</i>))			The band broadening coefficient (1.15 for the LI-7500).
		(CO2	(A <i>{float}</i>))	These values are found on the LI-7500's calibration sheet.
			(B <i>{float}</i>)		
			(C <i>{float}</i>)		
			(D <i>{float}</i>)		
			(E <i>{float}</i>)		
			(XS <i>{float}</i>)		
		(Z <i>{float}</i>)			
		(H2O	(A <i>{float}</i>))	
(B <i>{float}</i>)					
(C <i>{float}</i>)					
(XS <i>{float}</i>)					
(Z <i>{float}</i>)					

Examples:

1. To set the CO₂ zero right now (with the calibration tube in place and CO₂-free gas flowing through it, of course), send this:

```
(Calibrate(ZeroCO2(Date "11 Aug 1999 at 2:15")))
```

Note 1: The data value can be any string, so "My Birthday" is equally valid.

Note 2: The new value of zero will be sent in the next (Ack(Val..)) record. (See Table 2).

2. To force the H₂O channel to use the value 0.96 for its zero, send this:

```
(Calibrate(ZeroH2O(Val 0.96)))
```

3. To make the LI-7500 set its CO₂ span right now, with 400 μmol†mol⁻¹ flowing through the calibration tube, first compute the target density using Equation 2-24 (solved for C). If the temperature is 23°C, and the pressure 98kPa, then the mode density is 15.92 mmol CO₂ m⁻³. Then send the following:

```
(Calibrate(SpanCO2(Target 400)(TDensity 15.92)(Date "3 June 2000")))
```

The Program Reset Command

`(Program(Reset TRUE))` is the equivalent of pressing the reset button on the main board. It is generally only used to access lower level software for updating the embedded program, or when the instrument is not responding normally.

Table 5: Synchronization Commands

Command	Remarks
<code>(Program (Reset TRUE))</code>	Sending this will force the software to reset. This is equivalent to pressing the reset button on the board.

The Query Command

The Query (?) command is used to query the LI-7500 for any configuration parameter individually, as well as any node in the configuration tree.

Table 6: Query Commands

Command	Remarks
(Outputs ?) (Calibrate ?) (Coef ?) (Outputs ?) (Data ?) (Diagnostics ?) (EmbeddedSW ?) (Inputs ?)	The query for <i>individual parameters</i> works only for configuration parameters and <i>not</i> data or diagnostic information. All commands are followed by a line feed (lf).

Examples:

The query **(Outputs ?)lf** might respond:

```
(Outputs (BW 5)(Delay 25)(SDM (Address 7))(Dac1 (Source CO2A)(Zero -5e-
2)(Full 4e-1))
(Dac2 (Source H2OA)(Zero -1e-1)(Full 4e-1))(RS232 (Baud 38400)(Freq
5)(Pres TRUE)
(Temp TRUE)(Aux TRUE)(Cooler TRUE)(CO2Raw TRUE)(CO2D TRUE)(H2ORaw TRUE)
```

```
(H2OD TRUE)(Ndx TRUE)(DiagVal TRUE)(DiagRec TRUE)(Labels TRUE)(EOL
"0a")))
```

whereas the query **(Outputs(RS232(Freq ?)))If** would respond:

```
(Freq 5)
```

(Calibrate ?)If causes a Calibrate record to be put in the output queue.

Example Response:

```
(Calibrate (ZeroH2O (Val 9.9986296e-1)(Date "Aug 29 2000 at 1:43:59
PM"))(ZeroCO
2 (Val 1.3099210)(Date "Aug 29 2000 at 4:26:54 PM"))(SpanH2O (Val
9.8932171e-1)(
Target 1.5020001e1)(Tdensity 5.7752504e2)(Date "16 Jul 2000 at 18:54:26
"))(Spa
nCO2 (Val 1.0034980)(Target 9.9699993e2)(Tdensity 3.9138000e1)(Date "16
Jul 2000
at 18:46:10 ")))
```

(Coef)If causes a Coefficients record to be put in the output queue.

Example Response:

```
(Coef (Current (SerialNo ""))(CO2 (XS 6.1000003e-3)(Z 5.2999997e-3)(A
1.3511098e2
))(B 1.7224600e4)(C 2.9466302e7)(D -8.7606200e9)(E 1.2940900e12))(H2O (XS
-5.6999
```

```
997e-3)(Z 6.7999997e-3)(A 4.5109792e3)(B 2.9099099e6)(C 8.9501600e7))(Band
(A 1.
1499999)))))
```

(Outputs ?)If causes a Outputs record to be put in the output queue.

Example Response:

```
(Outputs (BW 10)(Delay 0)(SDM (Address 7))(Dac1 (Source NONE)(Zero -5e-
2)(Full 4
e-1))(Dac2 (Source PRESSURE)(Zero -1e-1)(Full 4e-1))(RS232 (Baud
38400)(Freq 0)(
Pres TRUE)(Temp TRUE)(Aux TRUE)(Cooler TRUE)(CO2Raw TRUE)(CO2D TRUE)(H2ORaw
TRUE
)(H2OD TRUE)(Ndx TRUE)(DiagVal TRUE)(DiagRec FALSE)(Labels FALSE)(EOL
"0D0A"))))
```

(Data ?)If causes a Data record to be put in the output queue. (Note that an ENQ (0x05) will do the same thing...)

Example Response:

```
(Data (Ndx 2471)(DiagVal 250)(CO2Raw 1.6319131e-1)(CO2D 3.5119712e1)(H2ORaw
3.16
72954e-2)(H2OD 1.7067077e2)(Temp 2.3874512e1)(Pres 9.8735609e1)(Aux
0)(Cooler 1.
5630015))
```

(Diagnostics ?)If causes a Diagnostics record to be put in the output queue.

Example Response:

```
(Diagnostics (SYNC TRUE)(PLL TRUE)(DetOK TRUE)(Chopper TRUE)(Path 65))
```

(EmbeddedSW ?)If causes an EmbeddedSW record to be put in the output queue.

Example Response:

```
(EmbeddedSW (Model "LI-7500 CO2/H2O Analyzer Application")(Version "2.0") )
```

(Inputs ?)If causes an Inputs record to be put in the output queue.

Example Response:

```
(Inputs (Pressure (Source Measured)(UserVal 9.8000002e1))(Temperature  
(Source Measured)(UserVal 2.5000000e1))(Aux (A 1)(B 0)))
```

Instrument Reset

If the reset button is pressed, or a break condition was transmitted, the following commands will not change from their previous state:

```
(Outputs (RS232 (EOL <bool>) (DiagRec <bool>) (Ndx <bool>)(Labels  
<bool>)(DiagVal <bool>)
```

LI7500 Windows Program Extensions

The *LI7500* Windows program extends the configuration grammar to store various settings used by the program but not the instrument. The (Chart..) record contains the Strip Chart Page settings, the (Connect..) record contains the Connect Page settings, and (Log..) contains the PC Logging Page settings.

Table 7: *LI7500* Windows Program Extensions (*Continued*)

Command	Subcommands		Remarks	
(Chart	(LV {quoted string})		Strip chart left variable	
	(LMax {float})		Left axis max value	
	(Lmin {float})		Left axis min value	
	(RV {quoted string})		Strip chart right variable	
	(Rmax {float})		Right axis max value	
	(Rmin {float})		Right axis min value	
	Scroll	(Coarse {bool }))	Time axis scrolling
		(Smooth {bool })		
	(Units	(Mins {bool }))	Time axis units
		(Secs {bool })		Time axis range
(Xmax {int})				

Appendix D

Command	Subcommands	Remarks
(Connect	(Baud { 9600 19200 38400 })	
	(Freq {float})) Value between 0 and 20.0
	(Port {int})) Value between 1 and 38.
(Log	(CI {bool })) Include cal information?
	(Del (Space {bool }) (Tab {bool }))) Which delimiter?
	(Name { quoted string })) Log file name
	(Rem {bool })) Include remarks?
	(TS {bool })) Include time stamp?

Command	Subcommands			Remarks
(Log	(LogVals	(CV {bool }))	Cooler voltage (V)
		(Cabs {bool })		CO ₂ absorption
		(Cden{bool })		CO ₂ mmol m ⁻³
		(CdenMg {bool })		CO ₂ mg m ⁻³
		(Cmf {bool })		CO ₂ μmol mol ⁻¹
		(Dew {bool })		H ₂ O Dew point (°C)
		(Habs {bool })		H ₂ O absorptance
		(Hden {bool })		H ₂ O mmol m ⁻³
		(HdenMg {bool })		H ₂ O g m ⁻³
		(Hmf{bool })		H ₂ O mmol mol ⁻¹
		(PortB {bool })		Auxiliary input channel
		(Pres {bool })		Pressure (kPa)
		(Temp{bool })		Temperature (°C)
		(RelTime {bool})		Relative Time (s)

The Connection Protocol

Introduction

The purpose of this section is to describe the protocol used to establish communications with the LI-7500 when it is operating in an “unknown” mode. That is, when the baud rate is not known, nor are any other details about the instrument’s configuration.

Note: For simple data collection, the LI-7500 can be configured with the *LI7500* Windows program, and you will not have to deal with this protocol at all. If you wish to write your own interface program or driver for the LI-7500, and you wish to get the LI-7500 to send its configuration to you, then this protocol must be used.

Establishing Communications: Step by Step

1. Set a break condition on the RS-232 line. 500 ms should be sufficient.
2. The LI-7500 will cease normal activity, change its baud rate to 9600 baud, and begin to send ascii ENQ characters (decimal 05) at a rate of 2 Hz for up to 10 seconds. Before 10 seconds are up, the host should:
3. Send an ascii ACK character (decimal 06) to the LI-7500.
4. Upon receipt of an ACK, the LI-7500 will output its current configuration, terminated with a line feed (decimal 10). A sample configuration is shown below. After this is sent, the LI-7500 will resume its normal operation, except it will remain at 9600 baud.

5. The host can then send the desired configuration changes, if any, to the LI-7500. If the configuration change involves a baud rate change, the LI-7500 will send its (Ack . .) record before changing baud rates.

A typical configuration dump as generated by the above protocol is shown below.

```
(Outputs (BW 10)(Delay 0)(SDM (Address 7))(Dac1 (Source CO2MMOL)(Zero 0)(Full 2e1))(Dac2 (Source PRESSURE)(Zero 0)(Full 1.2000000e3))(RS232 (Baud 38400)(Freq 0)(Pres TRUE)(Temp TRUE)(Aux TRUE)(Cooler TRUE)(CO2Raw TRUE)(CO2DTRUE)(H2ORaw TRUE)(H2OD TRUE)(Ndx TRUE)(DiagVal TRUE)(DiagRec TRUE)(Labels TRUE)(EOL "0D0A")))(Inputs (Pressure (Source Measured)(UserVal 9.8000002e1))(Temperature (Source Measured)(UserVal 2.5000000e1))(Aux (A 1)(B 0)))(Calibrate (ZeroH2O (Val 1.0166603)(Date "Feb 2 2001 at 10:12:21 AM"))(ZeroCO2 (Val 1.5645179)(Date "Feb 2 2001 at 11:40:01 AM"))(SpanH2O (Val 9.8932171e-1)(Target 1.5020001e1)(Tdensity 5.7752504e2)(Date "16 Jul 2000 at 18:54:26"))(SpanCO2 (Val 1.0034980)(Target 9.9699993e2)(Tdensity 3.9138000e1)(Date "16 Jul 2000 at 18:46:10"))(Coef (Current (Serial No "75H-0101")(CO2 (XS 6.1000003e-3)(Z 5.2999997e-3)(A 1.3511098e2)(B 1.7224600e4)(C 2.9466302e7)(D -8.7606200e9)(E 1.2940900e12))(H2O (XS -5.6999997e-3)(Z 6.7999997e-3)(A 4.5109792e3)(B 2.9099099e6)(C 8.9501600e7))(Band (A 1.1499999))))(EmbeddedSW (Model "LI-7500 CO2/H2O Analyzer Application")(Version "2.0.0"))
```

This is more clearly readable if parsed as shown below:

```
(Outputs
```

LI-COR[®]

LI-COR, inc. ● Environmental Division ● 4421 Superior Street ● P.O. Box 4425 ● Lincoln, Nebraska 68504 USA

Phone: 402-467-3576 ● FAX: 402-467-2819

Toll-free 1-800-447-3576 (U.S. & Canada)

E-mail: envsales@env.licor.com

Internet: <http://www.licor.com>